



# MagCore® Nucleic Acid Extraction Kit User's Manual

## CONTENTS

Precautions.....	1
IVD Symbols Reference.....	2
How to Use the Kit.....	3
<b>Introduction of Each MagCore® Nucleic Acid Extraction Kits</b>	
<i>Kit Contents, Description, Applications, Pretreatment, Protocol</i>	
-----	
<b>MagCore® Genomic DNA Whole Blood Kit (Speedy Installation).....</b>	<b>13</b>
<b>Cartridge Code 101</b> <small>Cat.No.MGB400-01//MGB400-02</small>	
<b>MagCore® Genomic DNA Whole Blood Kit.....</b>	<b>15</b>
<b>Cartridge Code 102</b> <small>Cat.No.MGB400-03//MGB400-04</small>	
<b>MagCore® Genomic DNA Large Volume Whole Blood Kit.....</b>	<b>17</b>
<b>Cartridge Code 104</b> <small>Cat.No.MGB1200</small>	
<b>MagCore® Plasma DNA Extraction Kit (1.2 ml).....</b>	<b>19</b>
<b>Cartridge Code 105</b> <small>Cat.No.MPD1200</small>	
<b>MagCore® Genomic DNA Whole Blood Kit (For Genotyping).....</b>	<b>21</b>
<b>Cartridge Code 106</b> <small>Cat.No.MGB400-07//MGB400-08</small>	
<b>MagCore® Cultured Cells DNA Kit.....</b>	<b>23</b>
<b>Cartridge Code 110</b> <small>Cat.No.MCC-01//MCC-02</small>	
<b>MagCore® Circulating DNA Large Volume Kit (4 ml).....</b>	<b>25</b>
<b>Cartridge Code 115</b> <small>Cat.No.MPD4000-01//MPD4000-03</small>	
<b>MagCore® Viral Nucleic Acid Extraction Kit.....</b>	<b>27</b>
<b>Cartridge Code 201</b> <small>Cat.No.MVN400-01//MVN400-02</small>	
<b>MagCore® Viral Nucleic Acid Extraction Kit.....</b>	<b>31</b>
<b>Cartridge Code 202</b> <small>Cat.No.MVN400-03//MVN400-04</small>	
<b>MagCore® Viral Nucleic Acid Extraction Kit (High Sensitivity).....</b>	<b>35</b>
<b>Cartridge Code 203</b> <small>Cat.No.MVN400-05//MVN400-06</small>	
<b>MagCore® Viral Nucleic Acid Large Volume Extraction Kit (2.4 ml).....</b>	<b>39</b>
<b>Cartridge Code 210</b> <small>Cat.No.MVN2400(HF16, Compact)</small>	
<b>MagCore® Viral Nucleic Acid Large Volume Extraction Kit (1.2 ml).....</b>	<b>41</b>
<b>Cartridge Code 211</b> <small>Cat.No.MVN1200</small>	
<b>MagCore® Genomic DNA Plant Kit.....</b>	<b>43</b>
<b>Cartridge Code 301</b> <small>Cat.No.MGP-01//MGP-02</small>	
<b>MagCore® Genomic DNA Tissue Kit.....</b>	<b>45</b>
<b>Cartridge Code 401</b> <small>Cat.No.MGT-01//MGT-02</small>	
<b>MagCore® Genomic DNA FFPE One-Step Kit.....</b>	<b>53</b>
<b>Cartridge Code 405</b> <small>Cat.No.MGF-01//MGF-03</small>	
<b>MagCore® Forensic DNA Direct Kit.....</b>	<b>57</b>
<b>Cartridge Code 406</b> <small>Cat.No.MFC-03</small>	
<b>MagCore® Genomic DNA Bacterial Kit.....</b>	<b>61</b>
<b>Cartridge Code 502</b> <small>Cat.No.MBB-01//MBB-02</small>	
<b>MagCore® Total RNA Whole Blood Kit.....</b>	<b>63</b>
<b>Cartridge Code 601</b> <small>Cat.No.MRN-01//MRN-02</small>	
<b>MagCore® Total RNA FFPE One-Step Kit.....</b>	<b>65</b>
<b>Cartridge Code 605</b> <small>Cat.No.MRF-01//MRF-03</small>	
<b>MagCore® Total RNA Cultured Cells Kit.....</b>	<b>69</b>
<b>Cartridge Code 610</b> <small>Cat.No.MRC-01//MRC-02</small>	
<b>MagCore® triXact RNA Kit.....</b>	<b>71</b>
<b>Cartridge Code 631</b> <small>Cat.No.MRX-01//MRX-03</small>	
-----	
<b>Running Time List.....</b>	<b>75</b>
<b>Product Selection Guide.....</b>	<b>78</b>
<b>Ordering Information.....</b>	<b>79</b>

# Precautions

## I) Before Using

- Do not operate MagCore® without qualified operation training.
- Read user's manual carefully before operation.

## II) Handling Requirements

- Do not use a kit after its expiration date.
- Do not touch the reagents with bare hands. Keep away from your skin, eyes, or mucous membranes. If contact does occur, wash the affected area immediately with large amounts of water. If you spill the reagents, dilute the spill with water before wiping it up.
- Do not allow reagents to mix with sodium hypochlorite solution or strong acids. This mixture can produce a highly toxic gas.



















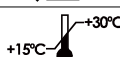
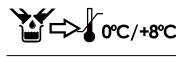
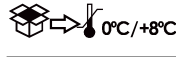

## III) Laboratory Procedures

- Handle all samples and the resulting waste as if potentially infectious, using safe laboratory procedures. As the sensitivity and titer of potential pathogens in the sample material varies, the operator has to optimize pathogen inactivation by the Lysis Buffer or take appropriate measures according to local safety regulations. RBC Bioscience does not warrant that samples treated with Lysis Buffer are completely inactivated and noninfectious. After sample processing is completed, remove and autoclave all disposable plastics.
- Do not eat, drink or smoke in the laboratory working area.
- Wear protective disposable gloves, laboratory coats and goggles when handling samples and kit reagents.
- Do not use sharp or pointed objects when working with the reagent cartridges, this is to prevent damage of the sealing foil and loss of reagent.
- Do not contaminate the reagents with bacteria, virus, or ribonuclease. Use disposable pipettes and RNase-free pipette tips only to remove aliquots from reagent bottles. Use the general precautions described in the literature.
- In the beginning and at the end of the protocol run, you may optionally choose to perform a UV decontamination run for 30 mins.
- Wash hands thoroughly after handling samples and test reagents.

## IV) Waste Handling

- Discard unused reagents and waste in compliance with country, federal, state and local regulations.

# IVD Symbols Reference

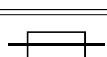
<i>Reference symbol</i>	<i>Description of Symbol</i>
	CE mark
	In Vitro Diagnostic Device
	Authorized representative in the European Community
	Manufacturer
	Content sufficient for <n> tests
	Warning: electricity
	Instruction manual must be read before operating
	Consult instructions for use
	Alternate current input
	Use-by Date
	No use period
	Temperature storage conditions +15°C/+30°C
	After mixing store at 0°C/+8°C
	After opening store at 0°C/+8°C
	Catalogue number (product code)
	Lot number
	Model
	Number of aliquots
	Included in the product
	Cartridge code number
	Sterile
	Sterilized using irradiation
	Serial Number
	Fuse

# How to Use the Kit - MagCore®HF16 and Compact

Install all necessary accessories and apply your specimen to MagCore®.

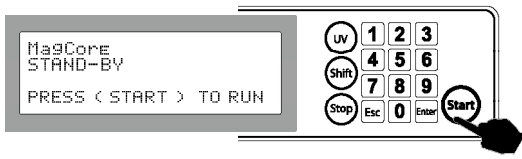

Press START.

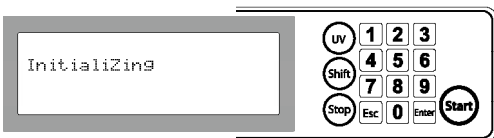

After press Start button, machine runs program of calibration, initialize to move all axis to original factory positions.

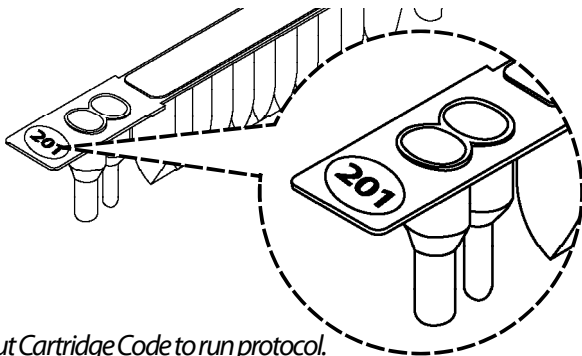

Input Cartridge Code to run protocol. Cartridge Code is shown on your Reagent Cartridge and at the cover of the user manual.

**!** The above CODE is for demonstration purposes only, please refer to the kit you purchase for proper program Code

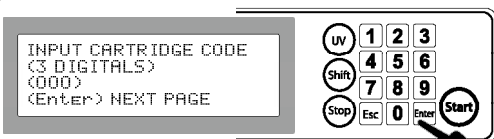

Confirm your input code again and press Enter to next page for sample volume selection.



Select Sample Volume.



Confirm your input Sample Volume. Press Enter for next page, Press ESC for back to Stand-By page.



At this step prepare racks to operation area. After racks are loaded, press Enter to next page for elution volume selection.

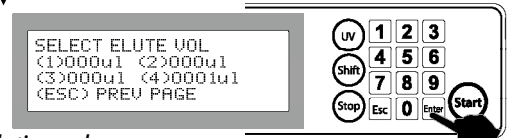

Select final elution volume.



MagCore® in process of selected protocol at this step. The Green Indicate LED lights up and Heating Block starts to heat up to 65°C for Lysis Step.

While MagCore® is under program running, the "MagCore" LCD lights up at all times.

DO NOT open the door at this moment, it causes emergent stop and you might lose your samples by machine interruption.



While program finished, a beep sound can be heard and Green Indicate LED light went out.

## Well Position of T-Rack

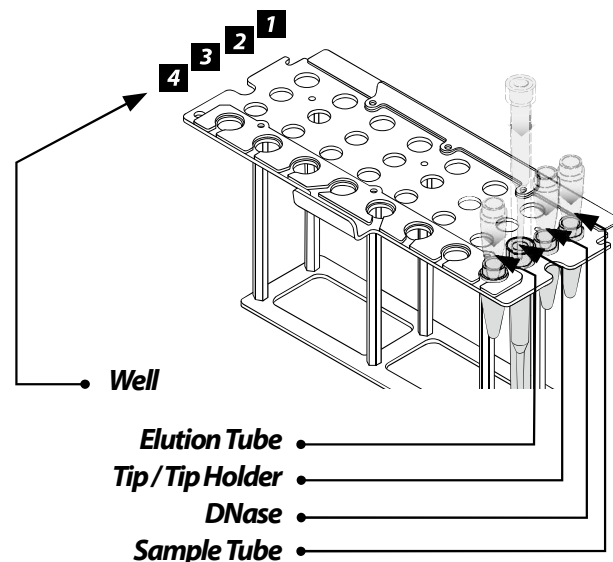



# How to Use the Kit - MagCore®HF48

## Install Tip and Sample Tube.

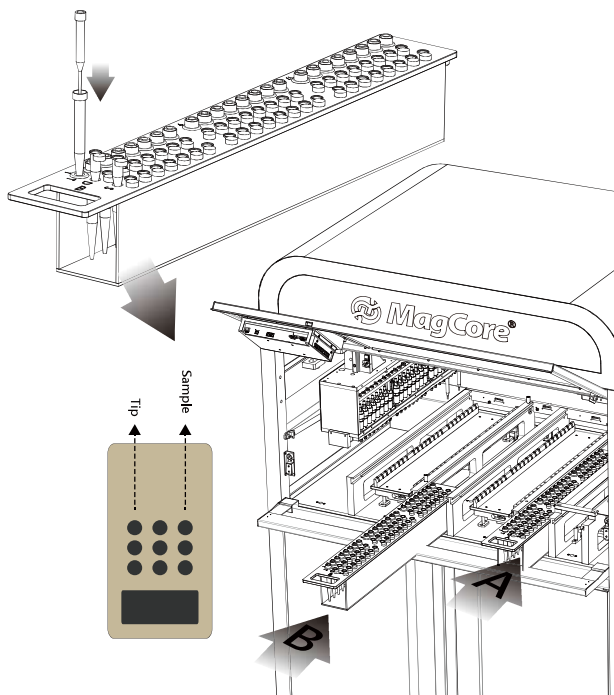

Insert the Tips and Sample Tubes in the slots of the Tip Carriers and then respectively put the whole sets of Tip carriers at the slots of the area A and area B according to the indicators.

## Install Cartridge

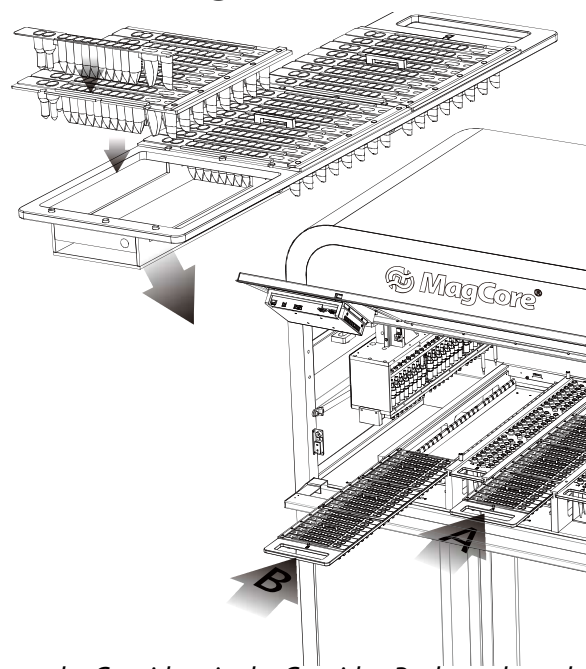

Insert the Cartridges in the Cartridge Racks and put the Cartridge Racks into the Cartridge Carriers and then respectively put the whole sets of Cartridge Carriers at the slots of the area A and area B according to the indicators

## Install Elution Tube

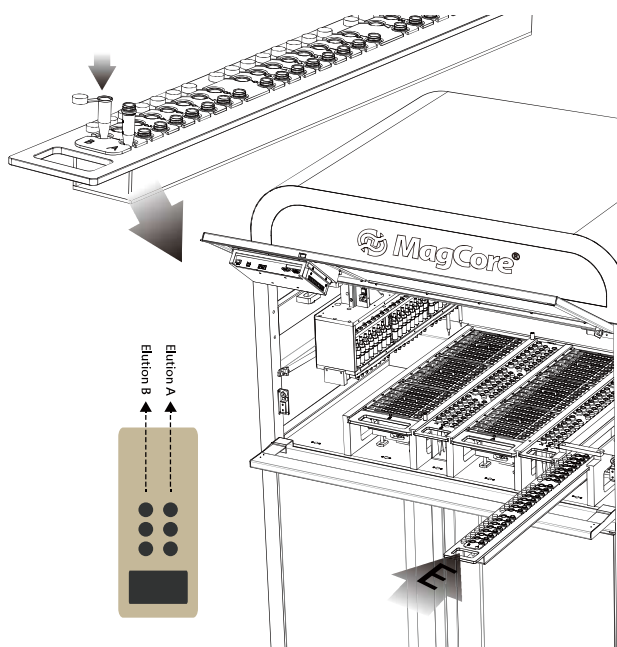

Put the Elution Tube in the corresponding positions according to the area A and area B and then put the Elution Carrier in the Elution slots.



### Warning:

The Carriers of the area A can only be used in the area A; similarly, the Carriers of the area B can only be used in the area B, or the system may not detect the Carriers and cannot work normally.

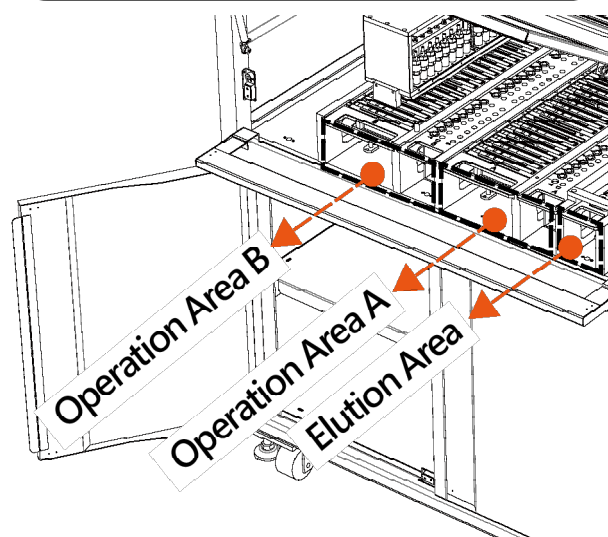

### Warning:

Please don't use any other centrifuge tubes to replace the Sample Tube of the reagent kit. The height of other sample tubes may be different from that of the Sample Tubes of the reagent kit, which may influence the extraction result.

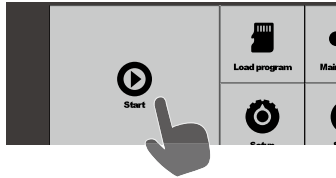

Press Start key in the main functional window.

**Next Step**

Select 24 or 48 test channels.

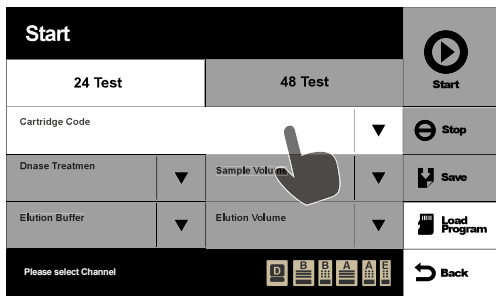

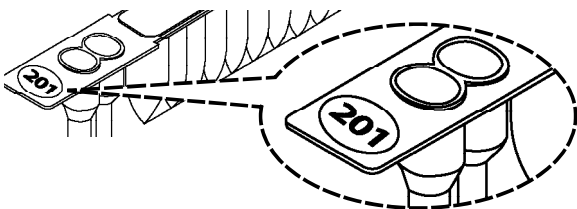

Select Cartridge Number.  
Cartridge Number is marked on the Cartridge you use.

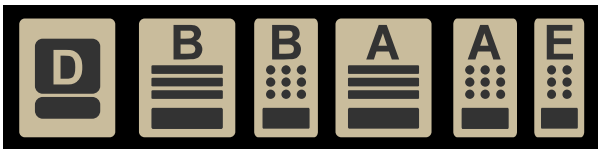

Please reconfirm the number you selected and select all parameters.

**Next Step**



Confirm that the icon  in the status bar is in normal status. If the icon shows , the Start key will be at "inactive" status and the operation is disabled. Please follow the display portion to remove error to solve. (Refer to page 8 for warning marks)

**Next Step**

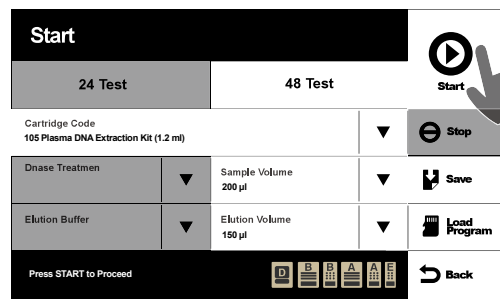

When you finish input and press Start key, the system will show a confirmation window, on which there are the parameters you input. Please press Yes to operate the system if the parameters are not incorrect. Please press No to modify incorrect parameters if you want to modify.

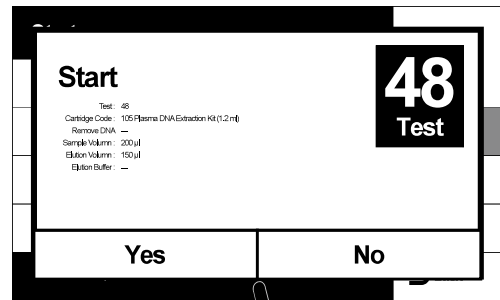

**Next Step**

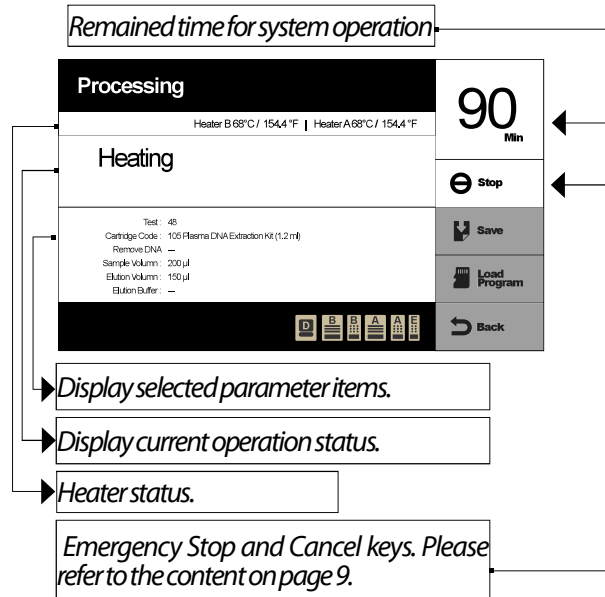

You may watch the procedure status and remained time of the current operation on the control panel. The system will display Complete page after completion.

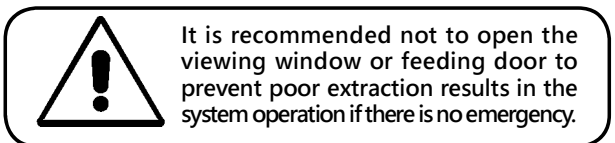
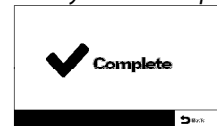

# How to Use the Kit—MagCore® Super / MagCore® HF16 Plus

## — Install MagCore® Cuvette (MagCore® Super Only / for optic test)

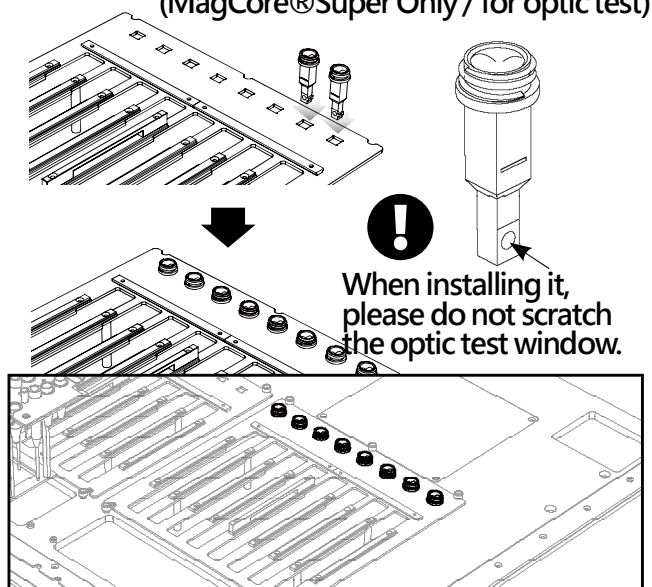

1. Please put MagCore® Cuvette into the corresponding sample's well. The installation of Cuvette is directional. It is impossible to put it into the well if the direction is not correct.
2. Put the 200 µl SP tip into the W4 of the T-Rack.

## Install Reagent Cartridge

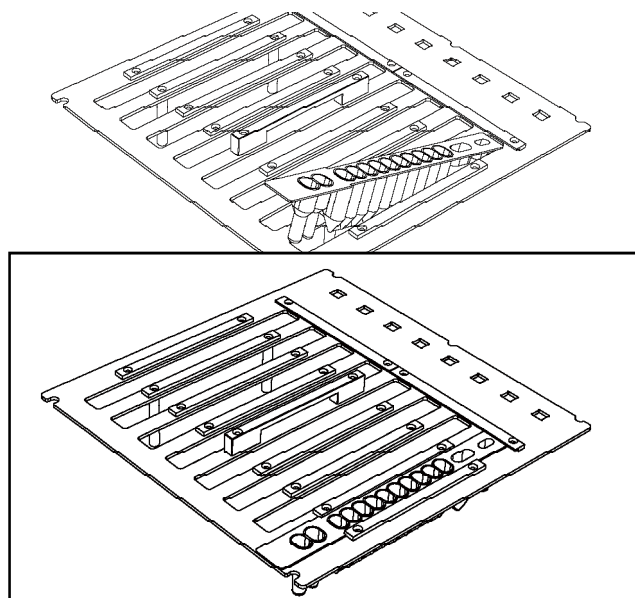

Please insert the front end of the cartridge into the space below the fixing plate of the Cartridge Rack.

- !** Please insert the Cartridge Rack before the T-Rack.

## — Install Tube, Tip

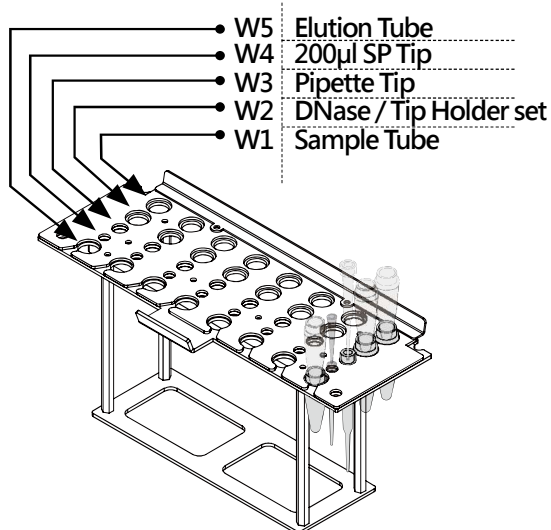

1. Put the tip into the corresponding well according to the left figure.
2. Put the T-Rack on the machine.

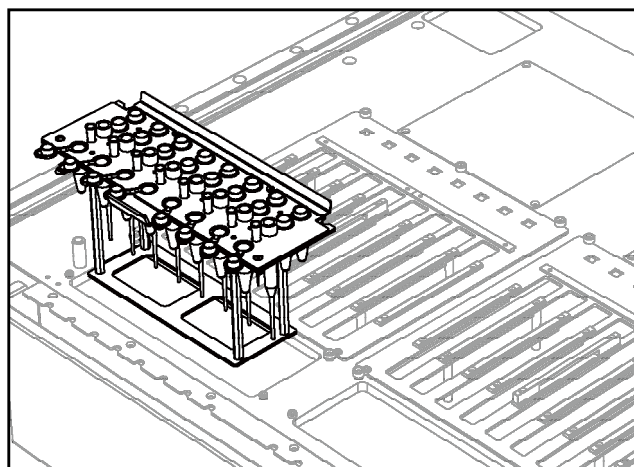

### Warning :

Please do not use the Tips and Tubes which are not provided by the original manufacturer. The test result may be not correct and the machine may be damaged due to different Tips and Tubes.

# – Start Programs

1 Please pretreat the sample according to the instructions of the user manual of the MagCore® Kit and put consumables into the machine.

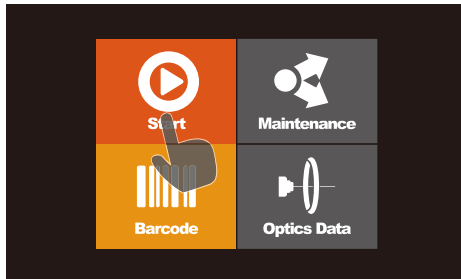

Press Start to go to the next step.

2

System will ask you whether or not to scan the barCode

If there is a barcode record from previous test processes, the system will ask you whether or not to delete previous barcode record. If there is no barcode record, the system will not ask you. (MagCore® Super only; HF16 Plus optional)

3 Please confirm the number of the reagent set which you install.

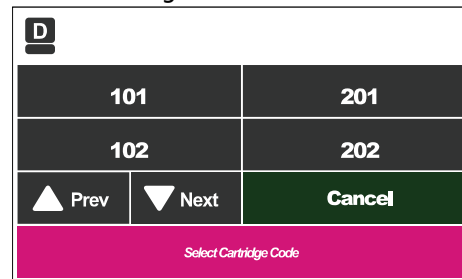
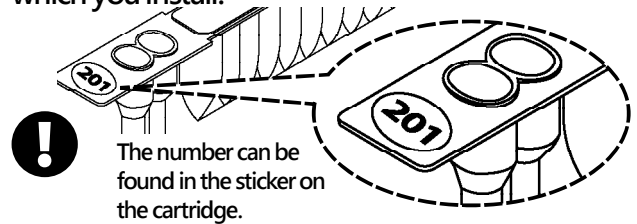

Select the number of the cartridge.

4

Select DNase Treatment. (Only for RNA kit.)

5

Select Sample Volume.

6

Select Elution Buffer. (Only for tissue kit.)

– If the test result of the optic measurement is over detection

7

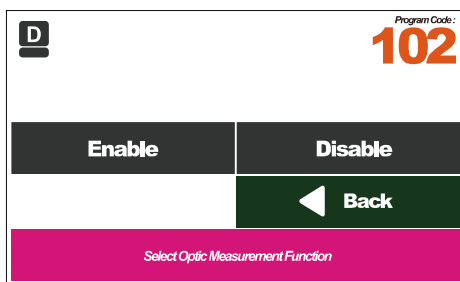

Select to enable or disable the optic measurement function. (MagCore®Super Only) (201, 202, 211, 105 without the function)

8

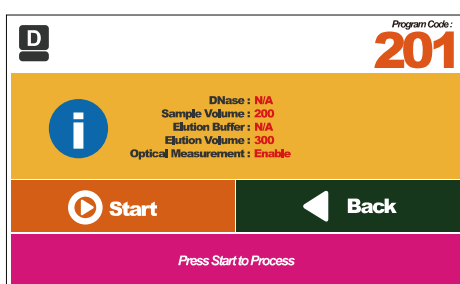

Please confirm the parameters and press the Start button to execute the program.

9

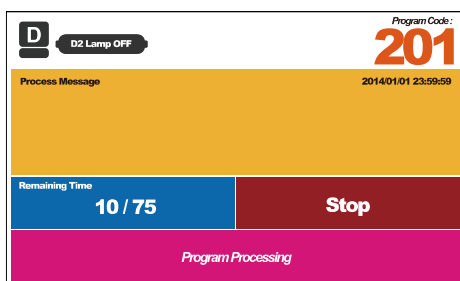

Automatic extraction process.

10

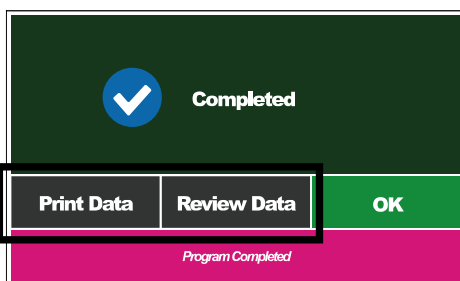

The extraction process is completed.

If you select the optic measurement function, you can browse, print or output the test result to a USB Flash Drive.

(MagCore®Super Only)

1

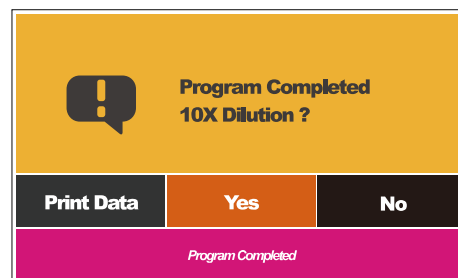

If the test result of the optic test shows the concentration is over detection (DNA > 300ng/μl / RNA > 240 ng/μl), the system will ask you to dilute.



A. Please record and save the current measured data.

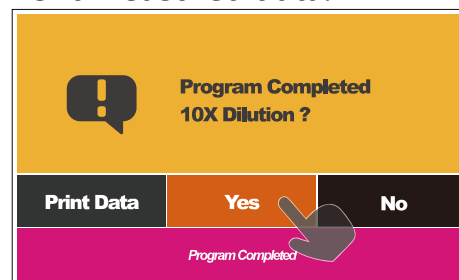

Please select YES.

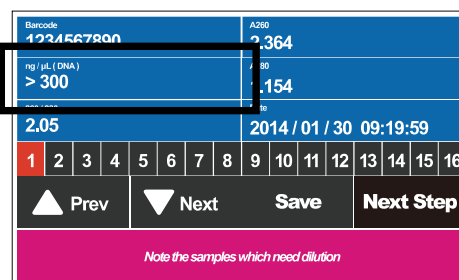

The values are DNA > 300 ng/μl / RNA > 240 ng/μl

Please check the value of each sample. If there is a value showing DNA > 300 ng/μl or RNA > 240 ng/μl, please record the number of the sample. It means the sample needs to be diluted. After recording the number of the slot, please insert the USB Flash Drive and press the Save button to save to current measured data. After finishing the above steps, please press Next Step.



Please save the data in the USB Flash Drive and transfer to computer, or the data in the USB Flash Drive may be overwritten later.

File name: OpticsSampleData.csv

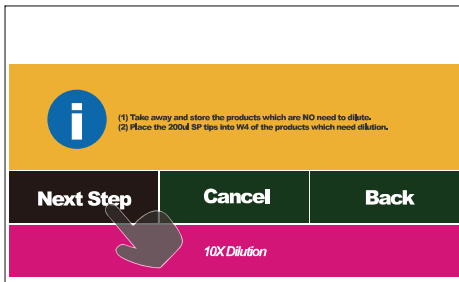

## B. Prepare to dilute

1. Please take out the elution products which are no need to be diluted.
2. Please put a new 200 $\mu$ l SP Tip in the W4 corresponding to the sample to be diluted.
3. Press Next Step to continue the process.

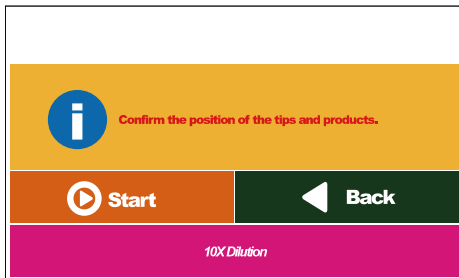

Please confirm and press Start to dilute it.



Diluting.

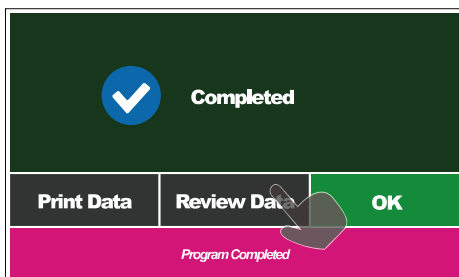

The diluting process is completed; please press Review Data to show the measured value after dilution.

Barcode 1234567890	A260 2.364														
ng / $\mu$ l (DNA) 118.2	A280 1.154														
260 / 280 2.05	Date 2014 / 01 / 30 09:19:59														
1	2	3	4	5	6	7	8	9	10	11	12	13	14	15	16
▲ Prev		▼ Next		Save		Back									
 <span style="float: right;">Optical Data</span>															

## C. Record and save the measured values.

1. Insert the USB Flash Drive and then press the Save button to save the current measured values after the USB icon shows in the status bar. Please take out the USB Flash Drive and then you can perform other operations after the icon of USB Flash Drive disappears.
2. The file saved last time and this file are all data obtained from this test. If the file saved last time is lost, you can retrieve this file according to the instructions of optic test data chapter.



Please save the data in the USB Flash Drive and transfer to computer, or the data in the USB Flash Drive may be overwritten later.

File name:  
OpticsSampleData.csv

Previous file name:  
Pre\_OpticsSampleData.csv



## How to Use the Kit – MagCore® Plus II

Please insert the front end of the cartridge into the space below the fixing plate of the Cartridge Rack.

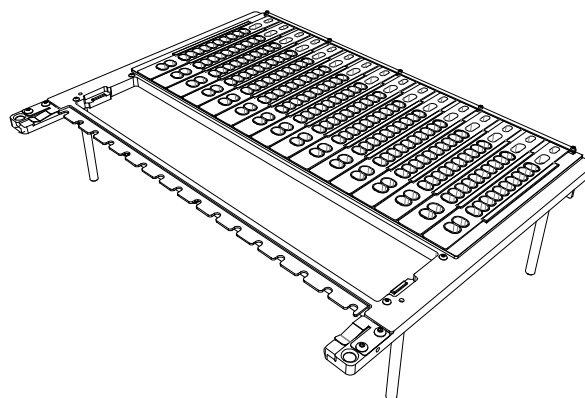
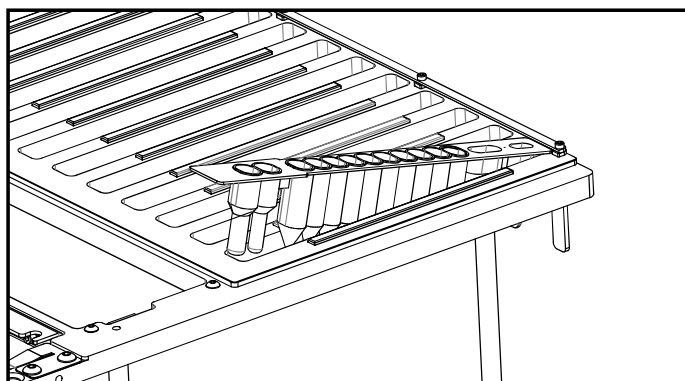

Please insert the Cartridge Rack before the T-Rack.

### – Install Tube, Tip

- W5 Elution Tube
- W4 200µl SP Tip
- W3 Pipette Tip
- W2 DNase / Tip Holder set
- W1 Sample Tube - FS Tip

1. Put the tip into the corresponding well according to the left figure.
2. Put the T-Rack on the machine.

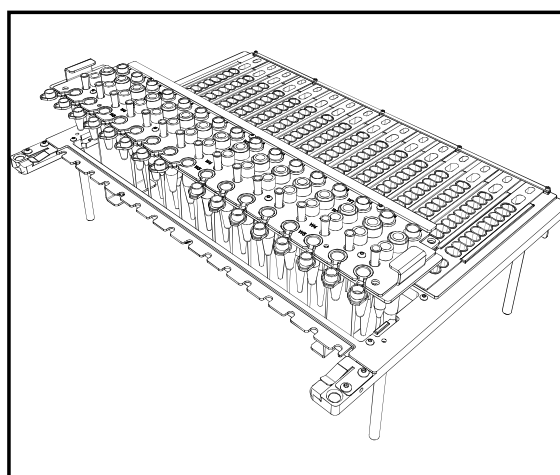
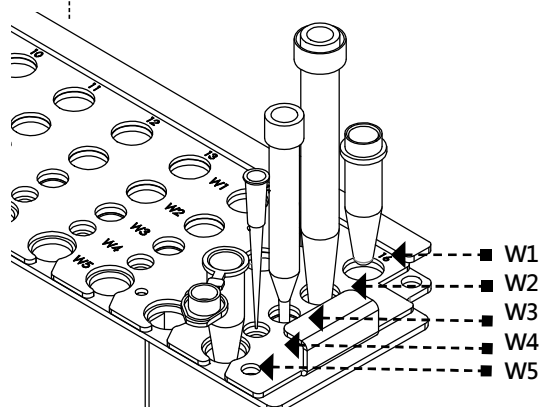

Please install the Tip and Tube according to the instructions of extraction kit user manual.



### Warning :

Please do not use the Tips and Tubes which are not provided by the original manufacturer. The test result may be not correct and the machine may be damaged due to different Tips and Tubes.

## – Start Programs

Please pretreat the sample according to the instructions of the user manual of the MagCore® Kit and put consumables into the machine.

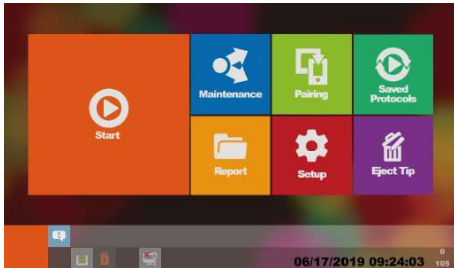

Press Start to go to the next step.

To Select User and Scan Barcodes: Please refer to Page 12 on the MagCore® Plus II Operation Manual.

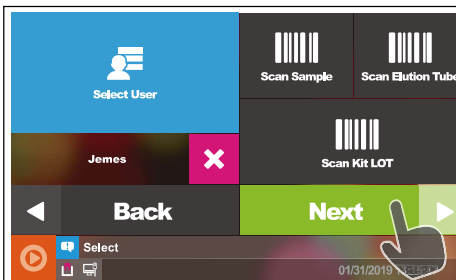

Press Next to choose the code number.

Please confirm the reagent set code number to be used in the extraction.



Select the number of the cartridge.

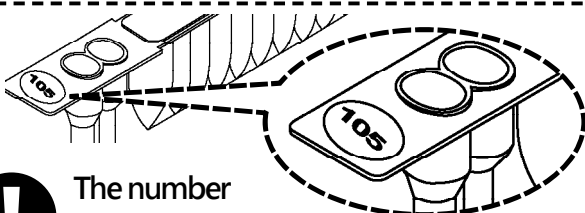

The number can be found in the sticker on the cartridge.

Select DNase Treatment. (Only for RNA kit.)



Select Sample Volume.



Select Elution Volume.

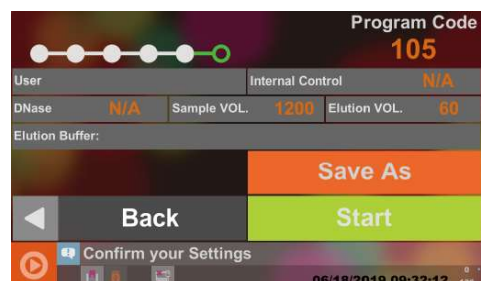

Close the door and press Start.





## MagCore® Genomic DNA Whole Blood Kit (Speedy Installation)

For purification of genomic DNA from human whole blood

Applicable Models : HF16, Compact, HF48, Super, HF16 Plus, Plus II

### Cartridge Code 101

Cat.No.MGB400-01 // MGB400-02

#### Kit Contents

Check that the following parts are included in addition to the main unit:

##### Cat.No. MGB400-01 Contents:

Pre-filled Cartridge Reagent.....	36 pcs.
Pipet Tip plus Holder Set.....	36 sets.
Sample Tube.....	36 pcs.
Elution Tube.....	36 pcs.

##### Cat.No. MGB400-02 Contents:

Pre-filled Cartridge Reagent.....	96 pcs.
Pipet Tip plus Holder Set.....	100 sets.
Sample Tube.....	100 pcs.
Elution Tube.....	100 pcs.

#### Storage and Stability:

1. This kit should be stored at room temperature.
2. Shelf Life: 12 Months.

#### Cartridge Contents:

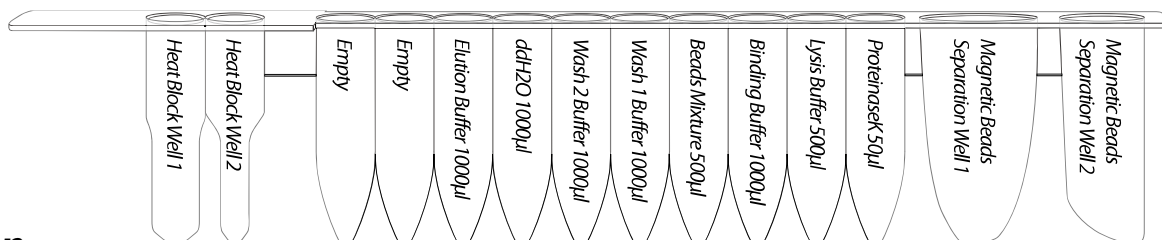

### Description

MagCore® Genomic DNA Whole Blood Kit is designed for purification of total DNA (including genomic, mitochondrial and viral DNA) from whole blood, plasma, serum, buffy coat by using MagCore® auto-extraction instrument. The method uses pre-filled cartridge which contains proteinase K and chaotropic salt to lyse cells and degrade protein.

DNA will bind to cellulose coated Magnetic Beads. After washing off the contaminants, the purified DNA is eluted by low salt elution buffer. Purified DNA of approximately 20-30 kb in length is suitable for PCR or other enzymatic reactions.

### Applications

Using magnetic-particle technology to purify genomic DNA from fresh whole blood. The purified genomic DNA can be directly used for downstream application such as quantitative PCR, restriction enzyme digestion, southern blotting, etc.

## Whole Blood Protocol

1. Pipet 200/400µl of equilibrated whole blood sample to MagCore® Sample Tube.
2. Put the prepared Sample Tube into the correct well of T-Rack.
3. Put Elution Tube and Tip Plus Holder Set (HF16, Compact)/Pipette Tip (Super, Plus) into the correct wells of the T-Rack. (see page 3-10)
4. Run Code 101 program at MagCore®.

### Optional Step: RNA Degradation

If RNA-Free genomic DNA is required, perform these optional steps.

1. Add 4µl RNase A (50mg/ml; not provided) into the sample lysate.
2. Incubate the sample at room temperature for 20min.

## Buffy Coat Modify Protocol

### RBC Lysis Buffer:

150mM NH<sub>4</sub>Cl, 10mM KHCO<sub>3</sub>, 0.1mM EDTA.

### Buffy Coat Preparation by RBC Lysis

1. Take 600~700µl whole blood into 2ml microcentrifuge tube.
- Don't take more than 700µl whole blood sample; it will cause the leakage situation during process.
2. Add 1ml RBC Lysis Buffer and mix the buffer and whole blood sample by upside down.
  3. Shake the mixture, 100rpm 5mins.
  4. Centrifuge the mixture at 13,000 rpm for 1 min.
  5. Discard supernatant.
  6. Repeat steps 2~5 to wash the sample again.
  7. Add 400µl RBC Lysis Buffer to resuspend the pellet and transfer into MagCore® Sample Tube.
  8. Put the prepared Sample Tube into the correct well of T-Rack. (see page 3-10)
  9. Put Elution Tube and Tip Plus Holder Set (HF16, Compact)/Pipette Tip (Super, Plus) into the correct wells of T-Rack. (see page 3-10)
- Run Code 101 program at MagCore®.

### Buffy Coat Preparation by Centrifugation

1. Take 2~5ml whole blood sample and centrifuge at 1,500rpm 10mins.
2. Use plastic drop to take white buffy coat layer in the middle of whole blood sample.
3. Move the buffy coat into new microcentrifuge tube.
4. Take 80~100µl buffy coat sample into MagCore® Sample Tube and add RBC Lysis Buffer or PBS until 400µl.
5. Put the prepared Sample Tube into the correct well of T-Rack.
6. Put Elution Tube and Tip Plus Holder Set (HF16, Compact)/Pipette Tip (Super, Plus) into the correct wells of T-Rack. (see page 3-10)
7. Run Code 101 program at MagCore®.

**Note:** We suggest to select 150~200µl elution buffer, it can get better elution efficiency in both of these methods. Normally the concentration is higher than 150ng/µl under such elution volume.

## **MagCore® Genomic DNA Whole Blood Kit**

**For purification of genomic DNA from human whole blood**

**Applicable Models : HF16, Compact, HF48, Super, HF16 Plus, Plus II**

### **Cartridge Code 102**

Cat.No.MGB400-03//MGB400-04

#### **Kit Contents**

Check that the following parts are included in addition to the main unit:

**Cat.No. MGB400-03 Contents:**

Pre-filled Cartridge Reagent.....	36 pcs.
Pipet Tip plus Holder Set.....	36 sets.
Sample Tube.....	36 pcs.
Elution Tube.....	36 pcs.
Proteinase K(11mg).....	2 pcs.
PK Storage Buffer.....	2 pcs.

**Cat.No. MGB400-04 Contents:**

Pre-filled Cartridge Reagent.....	96 pcs.
Pipet Tip plus Holder Set.....	100 sets.
Sample Tube.....	100 pcs.
Elution Tube.....	100 pcs.
Proteinase K(11mg).....	4 pcs.
PK Storage Buffer.....	4 pcs.

**Storage and Stability:**

1. This kit should be stored at room temperature.
2. Proteinase K should be stored at 2-8 °C upon arrival.
3. Shelf Life: 18 Months.

**Cartridge Contents:**

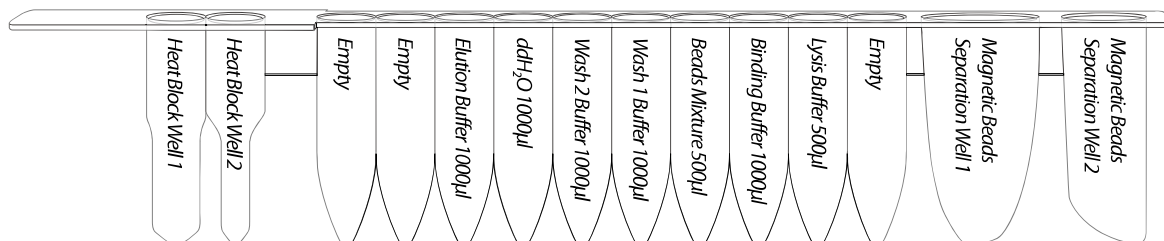

#### **Description**

MagCore® Genomic DNA Whole Blood Kit is designed for purification of total DNA (including genomic, mitochondrial and viral DNA) from whole blood, plasma, serum, buffy coat by using MagCore® auto-extraction instrument. The method uses a pre-filled cartridge which contains chaotropic salt to lyse cells and degrade protein. DNA will bind to cellulose coated magnetic beads. After washing off the contaminants, the purified DNA is eluted by low salt elution buffer. Purified DNA of approximately 20-30 kb in length is suitable for PCR or other enzymatic reactions.

#### **Applications**

Using magnetic-particle technology to purify genomic DNA from fresh whole blood. The purified genomic DNA can be directly used for downstream application such as quantitative PCR, restriction enzyme digestion, southern blotting, etc.

## Preparation Before Using

1. Add 1.1ml PK Storage Buffer to the Proteinase K tube and mix by vortexing. Store prepared Proteinase K (10mg/ml) at 2-8 °C

## Whole Blood Protocol

1. Take a new Sample Tube and add 20µl of Proteinase K (10mg/ml) to 200µl of equilibrated whole blood sample. (40µl Proteinase K to 400µl whole blood).
2. Put the prepared Sample Tube into the correct well of T-Rack. (see page 3-10)
3. Put Elution Tube and Tip Plus Holder Set (HF16, Compact) / Pipette Tip (Super, Plus) into the correct wells of the T-Rack. (see page 3-10)  
Run Code 102 program at MagCore®.

### Optional Step: RNA Degradation

If RNA-Free genomic DNA is required, perform these optional steps before adding Proteinase K.

1. Add 4µl RNase A (50mg/ml; not provided) into the sample lysate.
2. Incubate the sample at room temperature for 20mins.

## Buffy Coat Modify Protocol

### RBC Lysis Buffer:

150mM NH<sub>4</sub>Cl, 10mM KHCO<sub>3</sub>, 0.1mM EDTA.

### Buffy Coat Preparation by RBC Lysis

1. Take 600 ~ 700µl whole blood into 2ml microcentrifuge tube.  
Don't take more than 700µl whole blood sample; it will cause leaking during process.
2. Add 1ml RBC Lysis Buffer and mix the buffer and whole blood sample doing upside down movements.
3. Shake the mixture at 100 rpm for 5 mins.
4. Centrifuge the mixture at 13,000 rpm for 1 min.
5. Discard supernatant.
6. Repeat steps 2 ~ 5 to wash the sample again.
7. Add 400µl RBC Lysis Buffer and add 40µl of proteinase K to resuspend the pellet and transfer into MagCore® Sample Tube.
8. Put the prepared Sample Tube into the correct well of T-Rack. (see page 3-10)
9. Put Elution Tube and Tip Plus Holder Set (HF16, Compact) / Pipette Tip (Super, Plus) into the correct wells of T-Rack. (see page 3-10)
10. Run Code 102 program at MagCore®.

### Buffy Coat Preparation by Centrifugation

1. Take 2 ~ 5ml whole blood sample and centrifuge at 1,500 rpm for 10 mins.
2. Use plastic drop to take white buffy coat layer in the middle of whole blood sample.
3. Move the buffy coat into new microcentrifuge tube.
4. Take 80 ~ 100µl buffy coat sample into MagCore® Sample Tube and add RBC Lysis Buffer or PBS until 400µl then add 40µl of proteinase K.
5. Put the prepared Sample Tube into the correct well of T-Rack.
6. Put Elution Tube and Tip Plus Holder Set (HF16, Compact) / Pipette Tip (Super, Plus) into the correct wells of T-Rack. (see page 3-10)
7. Run Code 102 program at MagCore®.

**Note:** We suggest to select 150 ~ 200µl elution buffer, it can get better elution efficiency in both of these methods. Normally the concentration is higher than 150ng/µl under such elution volume.

## MagCore® Genomic DNA Large Volume Whole Blood Kit

For purification of genomic DNA from human whole blood (1.2 ml)  
Applicable Models : HF16, Compact, HF48, Super, HF16 Plus, Plus II

### Cartridge Code 104

Cat.No. MGB1200

#### Kit Contents

Check that the following parts are included in addition to the main unit:

**Cat.No. MGB1200 Contents:**

Pre-filled Cartridge Reagent.....	96 pcs.
Pipet Tip plus Holder Set.....	100 sets.
Sample Tube.....	100 pcs.
Elution Tube.....	100 pcs.
Proteinase K(11 mg).....	8 pcs.
PK Storage Buffer.....	8 pcs.

**Storage and Stability:**

1. This kit should be stored at room temperature.
2. Proteinase K should be stored at 2-8 °C upon arrival.
3. Shelf Life: 18 Months.

**Cartridge Contents:**

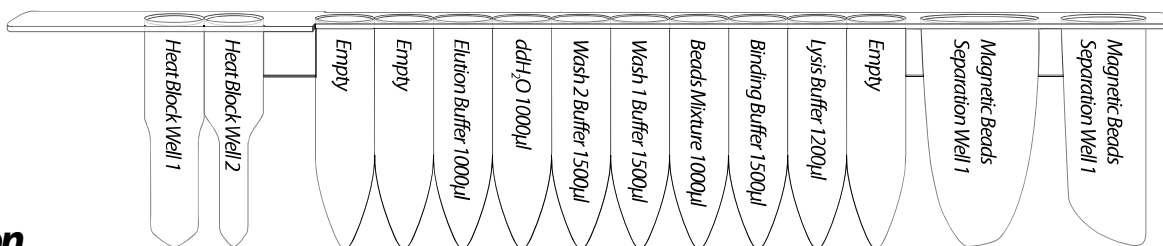

### Description

MagCore® Genomic DNA Large Volume Whole Blood kit is designed to extract genomic DNA from 1.2ml fresh whole blood via MagCore® auto-extraction instrument. The kit contains all required reagents and labware for automated purification using magnetic-particle technology. Combination of an easy program selection of code number 104 in MagCore® and using MagCore® Genomic DNA Large Volume Whole Blood Kit can extract high quality genomic DNA.

### Applications

Using magnetic-particle technology to purify genomic DNA from 1.2ml fresh whole blood. The purified genomic DNA can be directly used for downstream application such as quantitative PCR, restriction enzyme digestion, southern blotting, etc.

## Preparation Before Using

1. Add 1.1ml PK Storage Buffer to the Proteinase K tube and mix by vortexing. Store prepared Proteinase K (10mg/ml) at 2-8 °C

## Protocol

1. Pipet Proteinase K 80µl into the MagCore® Sample Tubes.
2. Add 1200µl whole blood into the prepared Sample Tube.
3. Put the prepared Sample Tube into the correct well of T-Rack. (see page 3-10)
4. Put Elution Tube and Tip Plus Holder Set (HF16, Compact)/Pipette Tip (Super, Plus) into the correct wells of the T-Rack. (see page 3-10)
5. Run Code 104 program at MagCore®.

**Note:** Beads or precipitate in eluent might be present in viscous samples. This situation will not affect the yield, purity and downstream applications. Reduction of sample volume or simple centrifugation will remove the residual beads.

## MagCore® Plasma DNA Extraction Kit (1.2 ml)

For extraction of free circulating DNA from human plasma or serum.  
Applicable Models : HF16, Compact, HF48, Super, HF16 Plus, Plus II

### Cartridge Code 105

Cat.No. MPD1200

#### Kit Contents

Check that the following parts are included in addition to the main unit:

**Cat.No. MPD1200 Contents:**

Pre-filled Cartridge Reagent.....	96 pcs.
Pipet Tip plus Holder Set.....	100 sets.
Sample Tube.....	100 pcs.
Elution Tube.....	100 pcs.
Proteinase K(11 mg).....	2 pcs.
PK Storage Buffer.....	2 pcs.

**Storage and Stability:**

1. This kit should be stored at room temperature.
2. Proteinase K should be store at 2-8 °C upon arrival.
3. Shelf Life : 18 Months.

**Cartridge Contents :**

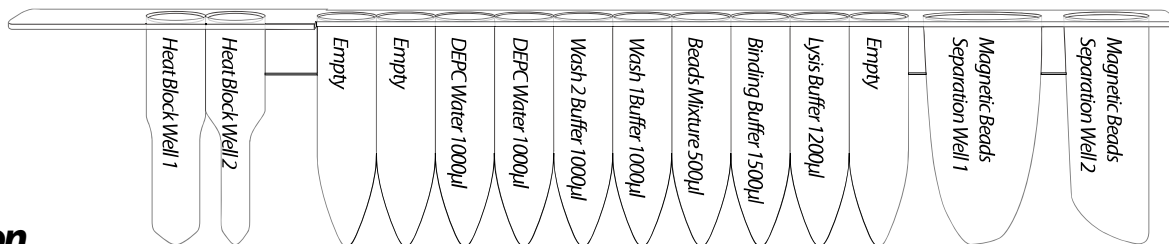

### Description

MagCore® Plasma DNA Extraction Kit is designed for purification of DNA from 1.2 ml of serum, plasma, cell-free body fluids by using MagCoreR auto-extraction instrument. With all the kit components of plastic consumables that are DNase/ RNase-Free pretreated and with individual processing track for each loaded sample, this system eliminates all possible cross contamination between samples. Built-in protocol with flexibility in sample source volumes, plasma DNA can be extracted using this kit in a fast and economical way.

### Applications

The purified total nucleic acid is suitable for highly sensitive and quantitative PCR. MagCore® Plasma DNA Extraction Kit has been proven with various genomic analyses as downstream applications.



## **Preparation Before Using**

1. Add 1.1ml PK Storage Buffer to the Proteinase K tube and mix by vortexing. Store prepared Proteinase K (10mg/ml) at 2-8°C

## **Protocol**

1. Pipet 20µl proteinase K (10mg/ml) into the MagCore® Sample Tubes.
2. Add 1200µl of serum, plasma, cell-free body fluids into the prepared Sample Tube.
3. After Proteinase K and Plasma mixing, stand for 10-20 min at room temperature, then centrifuge at 14,000 rpm for 5 min and transfer clear plasma to new tube.
4. Put the prepared Sample Tube into the correct well of T-Rack. (see page 3-10)
5. Put Elution Tube and Tip Plus Holder Set (HF16, Compact)/Pipette Tip (Super, Plus) into the correct wells of the T-Rack. (see page 3-10)
6. Run Code 105 program at MagCore®.

## MagCore® Genomic DNA Whole Blood Kit (For Genotyping)

Purify genomic DNA from human whole blood for genotyping.  
**Applicable Models : HF16, Compact, HF48, Super, HF16 Plus, Plus II**

### Cartridge Code 106

Cat.No.MGB400-07//MGB400-08

#### Kit Contents

Check that the following parts are included in addition to the main unit:

##### Cat.No. MGB400-07 Contents:

Pre-filled Cartridge Reagent.....	36 pcs.
Pipet Tip plus Holder Set.....	36 sets.
Sample Tube.....	36 pcs.
Elution Tube.....	36 pcs.
Proteinase K(11mg).....	2 pcs.
PK Storage Buffer.....	2 pcs.

##### Cat.No. MGB400-08 Contents:

Pre-filled Cartridge Reagent.....	96 pcs.
Pipet Tip plus Holder Set.....	100 sets.
Sample Tube.....	100 pcs.
Elution Tube.....	100 pcs.
Proteinase K(11mg).....	4 pcs.
PK Storage Buffer.....	4 pcs.

#### Storage and Stability:

1. This kit should be stored at room temperature.
2. Proteinase K should be stored at 2-8 °C upon arrival
3. Shelf Life: 18 Months.

#### Cartridge Contents:

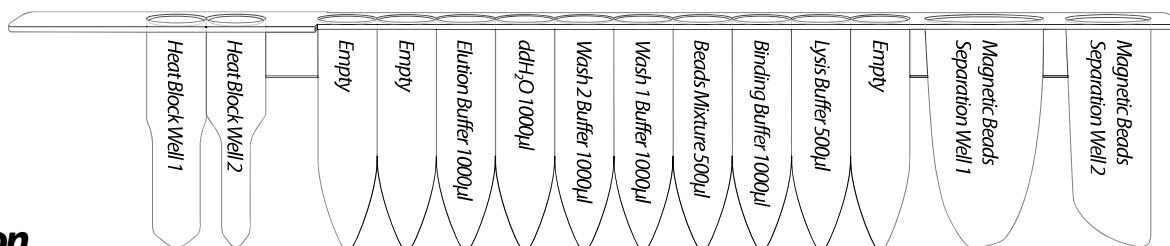

## Description

This kit is designed for genotyping application, you can get completed gDNA from eluent. We modified the reagent components and the machine operation to make this kit more suitable for genotyping. The pre-filled cartridge contains chaotropic salt and guanidine hydrochloride for cell lysis and protein degradation. The chaotropic salt helps the strong binding of DNA and cellulose coated magnetic beads. After the removal of contaminants, the high quality DNA is eluted by low salt elution buffer or water. Purified DNA of approximately 20-30 kb in length is suitable for genotyping or other applications.

## Applications

Use magnetic-particle technology to purify genomic DNA from whole blood and buffy coat. The purified genomic DNA can be directly used for downstream application such as genotyping, PCR, real-time PCR, restriction enzyme digestion, southern blotting, etc.

## Preparation Before Using

1. Add 1.1ml PK Storage Buffer to the Proteinase K tube and mix by vortexing. Store prepared Proteinase K (10mg/ml) at 2-8 °C

## Whole Blood Protocol

1. Take a new Sample Tube and add 20µl of Proteinase K (10mg/ml) to 200µl of equilibrated whole blood sample. (40µl Proteinase K to 400µl whole blood).
2. Put the prepared Sample Tube into the correct well of T-Rack. (see page 3-10)
3. Put Elution Tube and Tip Plus Holder Set (HF16, Compact) / Pipette Tip (Super, Plus) into the correct wells of the T-Rack. (see page 3-10)  
Run Code 106 program at MagCore®.

### Optional Step: RNA Degradation

If RNA-Free genomic DNA is required, perform these optional steps before adding Proteinase K.

1. Add 4µl RNase A (50mg/ml; not provided) into the sample lysate.
2. Incubate the sample at room temperature for 20min

## Buffy Coat modify Protocol

### RBC Lysis Buffer:

150mM NH<sub>4</sub>Cl, 10mM KHCO<sub>3</sub>, 0.1mM EDTA.

### Buffy Coat Preparation by RBC Lysis

1. Take 600 ~ 700µl whole blood into 2ml microcentrifuge tube.
- Don't take more than 700µl whole blood sample; it will cause leaking during process.
2. Add 1ml RBC Lysis Buffer and mix the buffer and whole blood sample doing upside down movements.
  3. Shake the mixture at 100 rpm for 5 mins.
  4. Centrifuge the mixture at 13,000 rpm for 1 min.
  5. Discard supernatant.
  6. Repeat steps 2 ~ 5 to wash the sample again.
  7. Add 400µl RBC Lysis Buffer and 40µl proteinase K to resuspend the pellet and transfer into MagCore® Sample Tube.
  8. Put the prepared Sample Tube into the correct well of T-Rack. (see page 3-10)
  9. Put Elution Tube and Tip Plus Holder Set (HF16, Compact) / Pipette Tip (Super, Plus) into the correct wells of the T-Rack. (see page 3-10)
  10. Run Code 106 program at MagCore®.

### Buffy Coat Preparation by Centrifugation

1. Take 2 ~ 5ml whole blood sample and centrifuge at 1,500 rpm for 10 mins.
2. Use plastic drop to take white buffy coat layer in the middle of whole blood sample.
3. Move the buffy coat into new microcentrifuge tube.
4. Take 80 ~ 100µl buffy coat sample into MagCore® Sample Tube and add RBC Lysis Buffer or PBS until 400µl then add 40µl of proteinase K.
5. Put the prepared Sample Tube into the correct well of T-Rack. (see page 3-10)
6. Put Elution Tube and Tip Plus Holder Set (HF16, Compact) / Pipette Tip (Super, Plus) into the correct wells of the T-Rack. (see page 3-10)
7. Run Code 106 program at MagCore®.

**Note:** We suggest to select 150 ~ 200µl elution buffer, it can get better elution efficiency in both of these methods. Normally the concentration is higher than 150ng/µl under such elution volume.

## MagCore® Cultured Cells DNA Kit

For extraction of genomic DNA from cultured cells and amniotic fluid.  
Applicable Models : HF16, Compact, HF48, Super, HF16 Plus, Plus II

### Cartridge Code 110

Cat.No. MCC-01 // MCC-02

#### Kit Contents

Check that the following parts are included in addition to the main unit:

##### Cat.No. MCC-01 Contents:

Pre-filled Cartridge Reagent.....	36 pcs.
Pipet Tip plus Holder Set.....	36 sets.
Sample Tube.....	36 pcs.
Elution Tube.....	36 pcs.
Proteinase K(11mg).....	1 pcs.
PK Storage Buffer.....	1 pcs.

##### Cat.No. MCC-02 Contents:

Pre-filled Cartridge Reagent.....	96 pcs.
Pipet Tip plus Holder Set.....	100 sets.
Sample Tube.....	100 pcs.
Elution Tube.....	100 pcs.
Proteinase K(11mg).....	2 pcs.
PK Storage Buffer.....	2 pcs.

#### Storage and Stability:

1. This kit should be stored at room temperature.
2. Proteinase K should be stored at 2-8 °C upon arrival.
3. Shelf Life: 18 Months.

#### Cartridge Contents :

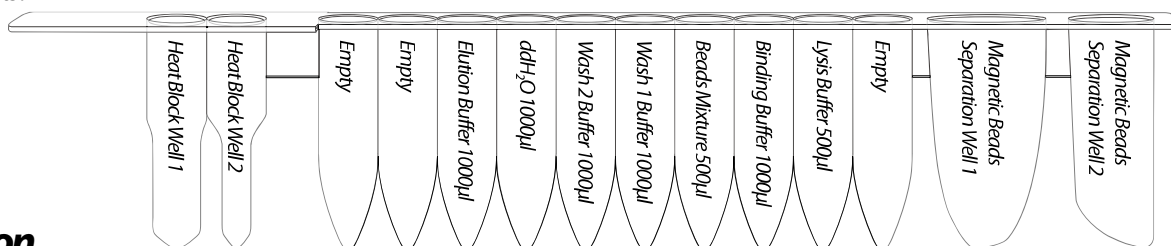

## Description

MagCore® Circulating DNA large volume kit is designed for purification of DNA from 4 ml of serum, plasma, cell-free body fluids by using MagCoreR auto-extraction instrument. With all the kit components of plastic consumables that are DNase/RNase-Free pretreated, and with individual processing track for each loaded sample, this system eliminates all possible cross contamination between samples. Built-in protocol with flexibility in sample source volumes, plasma DNA can be extracted using this kit in a fast and economical way.

## Applications

Using magnetic-particle technology to purify genomic DNA from  $5 \times 10^6$  cultured cells. The purified genomic DNA can be directly used for downstream applications such as quantitative PCR, restriction enzyme digestion, southern blotting, etc.

## Preparation Before Using

1. Add 1.1 ml PK Storage Buffer to the Proteinase K tube and mix by vortexing. Store prepared Proteinase K (10 mg/ml) at 2-8 °C
2. Ensure PBS buffer have been prepared for resuspend cell pellet.

## Protocol

### Sample Preparation

#### A. Cells grown in suspension

Cells grown in suspension (up to  $5 \times 10^6$  cells). Determine the number of cells. Centrifuge the appropriate number of cells for 5 min. at 300 x g in a 1.5 ml microcentrifuge tube (not provided). Remove the supernatant completely and discard. Continue with MagCore® Operation step 1.

#### B. Cells grown in a monolayer

Cells grown in a monolayer (up to  $5 \times 10^6$  cells). Cells grown in a monolayer can be detached from the culture flask by either trypsinization or using a cell scraper.

##### To trypsinize cells:

Determine the number of cells. Aspirate the medium and wash cells with PBS (not provided). Aspirate the PBS, and add 0.10–0.25% trypsin. After cells have detached from the dish or flask, collect them in medium, and transfer the appropriate number of cells (up to  $5 \times 10^6$  cells) to a 1.5 ml microcentrifuge tube (not provided). Centrifuge for 5 min. at 300 x g. Remove the supernatant completely and discard taking care to not to disturb the cell pellet. Continue with MagCore® Operation step 1.

##### Using a cell scraper:

Detach cells from the dish or flask. Transfer the appropriate number of cells (up to  $5 \times 10^6$  cells) to a 1.5 ml microcentrifuge tube and centrifuge for 5 min. at 300 x g. Remove the supernatant completely and discard taking care to not to disturb the cell pellet. Continue with MagCore® Operation step 1.

### MagCore® Operation

1. Resuspend cell pellet with PBS Buffer to a final volume of 200  $\mu$ l.
2. Transfer cell mixture 200  $\mu$ l and add 20  $\mu$ l Proteinase K into the MagCore® Sample Tubes.
3. Put the prepared Sample Tube into the correct well of T-Rack. (see page 3-10)
4. Put Elution Tube and Tip Plus Holder Set (HF16, Compact)/Pipette Tip (Super, Plus) into the correct wells of T-Rack. (see page 3-10)
5. Run Code 110 program at MagCore®.

## Amniotic Fluid Protocol

### Sample Preparation

1. Harvest cells from 10~15 ml amniotic fluid of 16~18 weeks by centrifugation for 10 minutes at 3000 rpm and discard the supernatant.
2. Add 200  $\mu$ l GT Buffer (not provided) to the tube and resuspend the cell pellet, then transfer mixture to new microcentrifuge tube.
3. Add 5~10  $\mu$ l Proteinase K (10 mg/ml) to the sample. Vortex for 5 seconds to mix sample.
4. Incubate at 56 °C for 10 minutes until the sample lysate is clear. During incubation, invert the tube every 3 minutes.
5. Spin down the sample and apply for MagCore®.

## MagCore® Circulating DNA Large Volume Kit (4 ml)

For extraction of free circulating DNA from human plasma or serum.  
Applicable Models : HF16, Compact, HF48, Super, HF16 Plus, Plus II

### Cartridge Code 115

Cat.No. MPD4000-01 //MPD4000-03

#### Kit Contents

Check that the following parts are included in addition to the main unit:

##### Cat.No. MPD4000-01 Contents:

Pre-filled Cartridge Reagent.....	24 pcs.
Pipet Tip plus Holder Set.....	25 sets.
5ml Sample Tube.....	25 pcs.
Elution Tube.....	25 pcs.
Proteinase K(11mg).....	3 pcs.
PK Storage Buffer.....	3 pcs.

##### Cat.No. MPD4000-03 Contents:

Pre-filled Cartridge Reagent.....	96 pcs.
Pipet Tip plus Holder Set.....	100 sets.
5ml Sample Tube.....	100 pcs.
Elution Tube.....	100 pcs.
Proteinase K(11mg).....	10 pcs.
PK Storage Buffer.....	10 pcs.

#### Storage and Stability:

1. This kit should be stored at room temperature.
2. Proteinase K should be stored at 2-8 °C upon arrival.
3. Shelf Life: 18 Months.

#### Cartridge Contents :

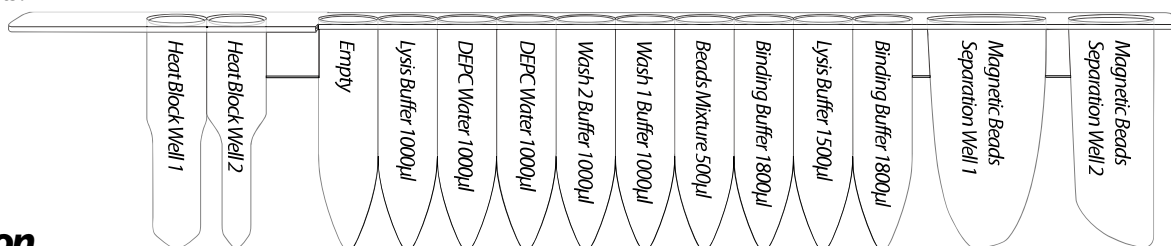

### Description

MagCore® Circulating DNA large volume kit is designed for purification of DNA from 3 ml or 4 ml of serum, plasma, cell-free body fluids by using MagCore® auto-extraction instrument. With all the kit components of plastic consumables are DNase/ RNase –Free pretreated, and individual processing track for each loaded samples, this system eliminates all possible cross contamination between samples. Built-in protocol with flexibility in sample source volumes, plasma DNA can be extracted using this kit in a fast and economical way.

### Applications

The purified total nucleic acid is suitable for highly sensitive and quantitative PCR. MagCore® Circulating DNA Large Volume Kit has been proven with various genomic analyses as downstream applications.

## **Preparation Before Using**

Add 1.1 ml PK Storage Buffer to the Proteinase K tube and mix by vortexing. Store prepared Proteinase K (10 mg/ml) at 2-8 °C

## **Protocol**

1. Add 4 ml of serum, plasma, cell-free body fluids (If the volume is less than 4 ml, add to 4 ml with 1X PBS.) into a DNase-free 15 ml tube (not provided).
2. Add 100 µl proteinase K (10 mg/ml) into 15 ml tube and mix by vortexing.
3. After Proteinase K and Plasma mixing, stand for 10-15 min at room temperature, then centrifuge at 14,000 rpm for 5 min and transfer clear plasma to 5 ml Sample Tube.
4. Put the prepared Sample Tube into the well 6 of the T-Rack.
5. Put the Pipette Tip into the well 3 of the T-Rack and the Elution Tube into the well 5 of the T-Rack.
6. Run Code 115 program at MagCore®.

## **MagCore® Viral Nucleic Acid Extraction Kit**

**For extraction of viral DNA/RNA from serum, plasma and cell-free body fluids.**

**Applicable Models : HF16, Compact, HF48, Super, HF16 Plus, Plus II**

### **Cartridge Code 201**

Cat.No. MVN400-01 // MVN400-02

#### **Kit Contents**

Check that the following parts are included in addition to the main unit:

**Cat.No. MVN400-01 Contents:**

Pre-filled Cartridge Reagent.....	36 pcs.
Pipet Tip plus Holder Set.....	36 sets.
Sample Tube.....	36 pcs.
Elution Tube.....	36 pcs.
Carrier RNA(1mg).....	1 pcs.
RNase Free Water.....	1 pcs.
Proteinase K(11mg).....	1 pcs.
PK Storage Buffer.....	1 pcs.

**Cat.No. MVN400-02 Contents:**

Pre-filled Cartridge Reagent.....	96 pcs.
Pipet Tip plus Holder Set.....	100 sets.
Sample Tube.....	100 pcs.
Elution Tube.....	100 pcs.
Carrier RNA(1mg).....	1 pcs.
RNase Free Water.....	1 pcs.
Proteinase K(11mg).....	2 pcs.
PK Storage Buffer.....	2 pcs.

**Storage and Stability:**

1. This kit should be stored at room temperature.
2. Carrier RNA should be stored at -20°C when mixing with RNase Free Water / Proteinase K should be stored at 2-8°C upon arrival.
3. Shelf Life: 18 Months.

**Cartridge Contents:**

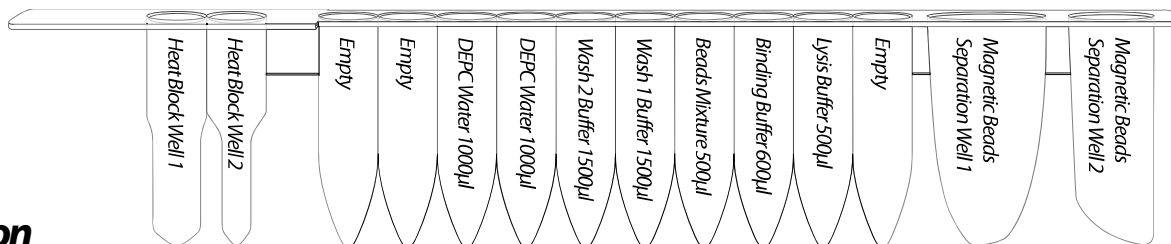

### **Description**

MagCore® Viral Nucleic Acid Extraction Kit is designed to extract viral DNA and RNA via MagCoreR auto-extraction instrument. With all the kit components of plastic consumables that are DNase/RNase-Free pretreated, and with individual processing track for each loaded sample, this system eliminates all possible cross contamination between samples. Built-in protocol with flexibility in sample source volumes, both DNA and RNA virus can be extracted using the same kit in a fast and economical way.

### **Applications**

Using magnetic-particle technology to purify viral nucleic acid from serum, plasma, or cell-free body fluids. The purified viral nucleic acid is suitable for highly sensitive and quantitative PCR.



## Preparation Before Using

1. Add 1.0 ml RNase Free Water to the Carrier RNA tube and mix by vortexing. Store prepared Carrier RNA (1 mg/ml) at -20°C.  
(Do not freeze-thaw the carrier RNA more than 3 times.)
2. Add 1.1 ml PK Storage Buffer to the Proteinase K tube and mix by vortexing. Store prepared Proteinase K (10 mg/ml) at 2-8 °C

## Protocol

1. Pipet 10 µl Carrier RNA (1 mg/ml) and 20 µl proteinase K (10 mg/ml) into the MagCore® Sample Tubes.
2. Add 200 µl or 400 µl of serum, plasma, or cell-free body fluids into the prepared Sample Tube.
3. Put the prepared Sample Tube into the correct well of T-Rack. (see page 3-10)
4. Put Elution Tube and Tip Plus Holder Set (HF16, Compact) / Pipette Tip (Super, Plus) into the correct wells of the T-Rack. (see page 3-10)
5. Run Code 201 program at MagCore®.

## Urine Protocol

### Sample Preparation

1. Harvest cells from up to 3.5 ml urine by centrifugation for 10 minutes at 3000 rpm and concentrate the sample to 400 µl
2. Add 5~10 µl Proteinase K (10 mg/ml) to the sample. Vortex for 5 seconds to mix sample.
3. Incubate at 56°C for 10 minutes until the sample lysate is clear. During incubation, invert the tube every 3 minutes.
4. Pipet 10 µl Carrier RNA (1 mg/ml) into the MagCore® Sample Tubes.
6. Put the prepared Sample Tube into the correct well of T-Rack. (see page 3-10)
7. Put Elution Tube and Tip Plus Holder Set (HF16, Compact) / Pipette Tip (Super, Plus) into the correct wells of the T-Rack. (see page 3-10)
8. Run Code 201 program at MagCore®.

## Swab Protocol

### \*Not Provided: GT Buffer and Filter Column Set.

1. Separate the swab cotton from the stick. Place the swab into a 2 ml microcentrifuge tube, add 500 µl or more GT buffer (not provided, Cat. No. S44050030, 30 ml) and 20 µl Proteinase K (10 mg/ml).
2. Incubate the sample lysate at 55°C for 30 min.  
For Buccal Swab sample, donor should not ingest anything for at least 30 min prior to sample collection.
3. If there are any insoluble residues in the tube, transfer the supernatant to a Filter Column (not provided, Cat. No. S42030001, 100 pcs; Cat. No. S42030002, 36 pcs) and centrifuge at full speed for 5 mins to get clear tissue solution in the Collection Tube.
4. Pipette 400 µl of clear tissue solution and 10 µl Carrier RNA (1 mg/ml) to the MagCore® Sample Tube.
5. Put the prepared Sample Tube into the W1 of the T-Rack.
6. Put Elution Tube into the W5 of the T-Rack and Pipette Tip into the W3 of the T-Rack.
7. Run Code **201** program at MagCore®.

## Respiratory Sample Protocol (Sputum)

### Reagents to Be Prepared by User

*Either Sputasol solution (not provided) or NAC buffer (not provided)*

1. Liquefy the sample following either step a. or b.
  - a. Add 1 volume of Sputasol solution to 1 volume of sample and shake. Incubate in water bath at 37°C and shake periodically until the sample is completely liquefied.
  - b. Mix 1 volume of sample with 1 volume of NAC buffer (10 g N acetylcysteine per liter of 0.9% NaCl solution). If the sample is very viscous solid, disrupt it mechanically by pipetting up and down. Incubate at room temperature for 30 min and shake periodically until completely liquefied.

*Note: if the sample is very viscous/solid, a longer incubation time with periodical shaking might be required.*

2. Centrifuge the liquefied sample until pellet is obtained, then transfer the clear supernatant to a clean tube.
3. Apply 200µl or 400µl of clear lysate and continue with MagCore Viral Kit general protocol step 1 (Carrier RNA and PK step).



## MagCore® Viral Nucleic Acid Extraction Kit

**For extraction of viral DNA/RNA from serum, plasma and cell-free body fluids**

**Applicable Models : HF16, Compact, HF48, Super, HF16 Plus, Plus II**

### Cartridge Code 202

Cat.No. MVN400-03 // MVN400-04

#### Kit Contents

Check that the following parts are included in addition to the main unit:

**Cat.No. MVN400-03 Contents:**

Pre-filled Cartridge Reagent.....	36 pcs.
Pipet Tip plus Holder Set.....	36 sets.
Sample Tube.....	36 pcs.
Elution Tube.....	36 pcs.
Carrier RNA(1mg).....	1 pcs.
RNase Free Water.....	1 pcs.
Proteinase K(11mg).....	1 pcs.
PK Storage Buffer.....	1 pcs.

**Cat.No. MVN400-04 Contents:**

Pre-filled Cartridge Reagent.....	96 pcs.
Pipet Tip plus Holder Set.....	100 sets.
Sample Tube.....	100 pcs.
Elution Tube.....	100 pcs.
Carrier RNA(1mg).....	1 pcs.
RNase Free Water.....	1 pcs.
Proteinase K(11mg).....	2 pcs.
PK Storage Buffer.....	2 pcs.

**Storage and Stability:**

1. This kit should be stored at room temperature.
2. Carrier RNA should be stored at -20°C when mixing with RNase Free Water / Proteinase K should be stored at 2-8°C upon arrival.
3. Shelf Life: 18 Months.

**Cartridge Contents:**

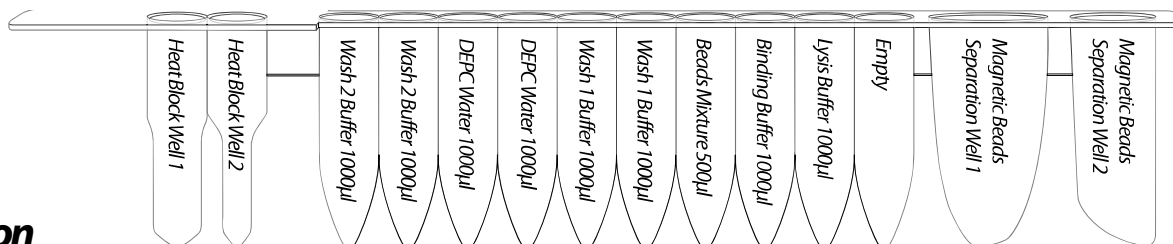

### Description

MagCore® Viral Nucleic Acid Extraction Kit is designed to extract viral DNA and RNA via MagCoreR auto-extraction instrument. With all the kit components of plastic consumables that are DNase/RNase-Free pretreated, and with individual processing track for each loaded sample, this system eliminates all possible cross contamination between samples. Built-in protocol with flexibility in sample source volumes, both DNA and RNA virus can be extracted using the same kit in a fast and economical way.

### Applications

Using magnetic-particle technology to purify viral nucleic acid from serum, plasma, or cell-free body fluids. The purified viral nucleic acid is suitable for highly sensitive and quantitative PCR.

## Preparation Before Using

1. Add 1.0 ml RNase Free Water to the Carrier RNA tube and mix by vortexing. Store prepared Carrier RNA (1 mg/ml) at -20°C. (Do not freeze-thaw the carrier RNA more than 3 times.)
2. Add 1.1 ml PK Storage Buffer to the Proteinase K tube and mix by vortexing. Store prepared Proteinase K (10 mg/ml) at 2-8°C

## Protocol

1. Pipet 10 µl Carrier RNA (1 mg/ml) and 20 µl proteinase K (10 mg/ml) into the MagCore® Sample Tubes.
2. Add 200 µl or 400 µl of serum, plasma, or cell-free body fluids into the prepared Sample Tube.
3. Put the prepared Sample Tube into the correct well of T-Rack. (see page 3-10)
4. Put Elution Tube and Tip Plus Holder Set (HF16, Compact) / Pipette Tip (Super, Plus) into the correct wells of the T-Rack. (see page 3-10)
5. Run Code 202 program at MagCore®.

## Urine Protocol

### Sample Preparation

1. Harvest cells from up to 3.5 ml urine by centrifugation for 10 minutes at 3000 rpm and concentrate the sample to 400 µl
2. Add 5~10 µl Proteinase K (10 mg/ml) to the sample. Vortex for 5 seconds to mix sample.
3. Incubate at 56°C for 10 minutes until the sample lysate is clear. During incubation, invert the tube every 3 minutes.
4. Pipet 10 µl Carrier RNA (1 mg/ml) into the MagCore® Sample Tubes.
6. Put the prepared Sample Tube into the correct well of T-Rack. (see page 3-10)
7. Put Elution Tube and Tip Plus Holder Set (HF16, Compact) / Pipette Tip (Super, Plus) into the correct wells of the T-Rack. (see page 3-10)
8. Run Code 202 program at MagCore®.

## Swab Protocol

### \*Not Provided: GT Buffer and Filter Column Set.

1. Separate the swab cotton from the stick. Place the swab into a 2 ml microcentrifuge tube, add 500 µl or more GT buffer (not provided, Cat. No. S44050030, 30 ml) and 20 µl Proteinase K (10 mg/ml).
2. Incubate the sample lysate at 55°C for 30 min.  
For Buccal Swab sample, donor should not ingest anything for at least 30 min prior to sample collection.
3. If there are any insoluble residues in the tube, transfer the supernatant to Filter Column (not provided, Cat. No. S42030001, 100 pcs; Cat. No. S42030002, 36 pcs) and centrifuge at full speed for 5 mins to get clear tissue solution in the Collection Tube.
4. Pipette 400 µl of clear tissue solution and 10 µl Carrier RNA (1 mg/ml) to the MagCore® Sample Tube.
5. Put the prepared Sample Tube into the W1 of the T-Rack.
6. Put Elution Tube into the W5 of the T-Rack and Pipette Tip into the W3 of the T-Rack.
7. Run Code 202 program at MagCore®.

## Respiratory Sample Protocol (Sputum)

### Reagents to Be Prepared by User

*Either Sputasol solution (not provided) or NAC buffer (not provided)*

1. Liquefy the sample following either step a. or b.
  - a. Add 1 volume of Sputasol solution to 1 volume of sample and shake. Incubate in water bath at 37°C and shake periodically until the sample is completely liquefied.
  - b. Mix 1 volume of sample with 1 volume of NAC buffer (10 g N acetylcysteine per liter of 0.9% NaCl solution). If the sample is very viscous solid, disrupt it mechanically by pipetting up and down. Incubate at room temperature for 30 min and shake periodically until completely liquefied.

*Note: if the sample is very viscous/solid, a longer incubation time with periodical shaking might be required.*

2. Centrifuge the liquefied sample until pellet is obtained, then transfer the clear supernatant to a clean tube.
3. Apply 200µl or 400µl of clear lysate and continue with MagCore Viral Kit general protocol step 1 (Carrier RNA and PK step).



## **MagCore® Viral Nucleic Acid Extraction Kit (High Sensitivity)**

**For extraction of viral DNA/RNA from serum, plasma and cell-free body fluids**

**Applicable Models : HF16, Compact, HF48, Super, HF16 Plus, Plus II**

### **Cartridge Code 203**

Cat.No. MVN400-05//MVN400-06

#### **Kit Contents**

Check that the following parts are included in addition to the main unit:

**Cat.No. MVN400-05 Contents:**

Pre-filled Cartridge Reagent.....	36 pcs.
Pipet Tip plus Holder Set.....	36 sets.
Sample Tube.....	36 pcs (two packages).
Elution Tube.....	36 pcs.
Carrier RNA(1mg).....	1 pcs.
RNase Free Water.....	1 pcs.
Proteinase K(11mg).....	1 pcs.
PK Storage Buffer.....	1 pcs.

**Cat.No. MVN400-06 Contents:**

Pre-filled Cartridge Reagent.....	96 pcs.
Pipet Tip plus Holder Set.....	100 sets.
Sample Tube.....	100 pcs (two packages).
Elution Tube.....	100 pcs.
Carrier RNA(1mg).....	1 pcs.
RNase Free Water.....	1 pcs.
Proteinase K(11mg).....	2 pcs.
PK Storage Buffer.....	2 pcs.

**Storage and Stability:**

1. This kit should be stored at room temperature.
2. Carrier RNA should be stored at -20°C when mixing with RNase Free Water / Proteinase K should be stored at 2-8°C upon arrival.
3. Shelf Life: 18 Months.

**Cartridge Contents:**

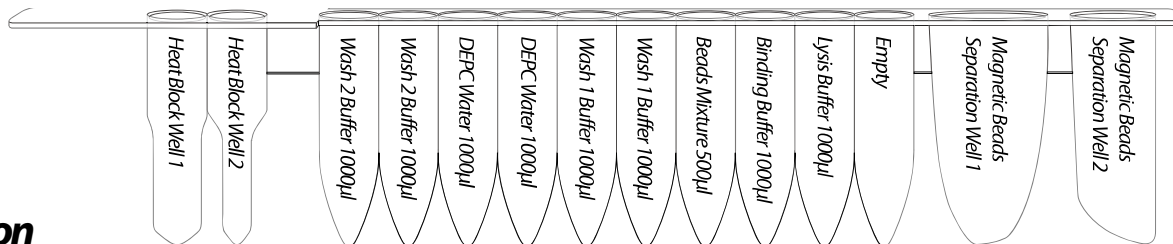

### **Description**

MagCore® Viral Nucleic Acid Extraction Kit is designed to extract viral DNA and RNA via MagCoreR auto-extraction instrument. With all the kit components of plastic consumables that are DNase/RNase-Free pretreated, and with individual processing track for each loaded sample, this system eliminates all possible cross contamination between samples. Built-in protocol with flexibility in sample source volumes, both DNA and RNA virus can be extracted using the same kit in a fast and economical way.

### **Applications**

Using magnetic-particle technology to purify viral nucleic acid from serum, plasma, or cell-free body fluids. The purified viral nucleic acid is suitable for highly sensitive and quantitative PCR.



## Preparation Before Using

1. Add 1.0 ml RNase Free Water to the Carrier RNA tube and mix by vortexing. Store prepared Carrier RNA (1 mg/ml) at -20°C.  
(Do not freeze–thaw the carrier RNA more than 3 times.)
2. Add 1.1 ml PK Storage Buffer to the Proteinase K tube and mix by vortexing. Store prepared Proteinase K (10 mg/ml) at 2-8 °C

## Protocol

1. Pipet 10 µl Carrier RNA (1 mg/ml) and 20 µl proteinase K (10 mg/ml) into the MagCore® Sample Tubes.
2. Add 200 µl or 400 µl of serum, plasma, or cell-free body fluids into the prepared Sample Tube.
3. **Internal Control (IC) Selection**  
Pipet the Internal Control (5, 10 or 20 µl, not provided) into a new Sample Tube.  
Place this sample tube into the W2 of the T-Rack.
  - a. HF16, Compact, Plus II: Select add IC (3) Yes or (4) No.
  - b. Super, HF16 Plus: Select Code **203A** for adding IC or Code **203B** for without IC.
4. Put the prepared Sample Tube into the W1 of the T-Rack.
5. Elution Tube Position
  - a. HF16, Compact: Put Elution Tube into the W4 of T-Rack and Pipette Tip into the W3 of T-Rack.
  - b. Super, HF16 Plus, Plus II: Put Elution Tube into the W5 of T-Rack and Pipette Tip into the W3 of T-Rack.
6. Run Code 203 (HF16, Compact, Plus II) or 203A/203B (Super, HF16 Plus) program at MagCore®.

## Urine Protocol

### Sample Preparation

1. Harvest cells from up to 3.5 ml urine by centrifugation for 10 minutes at 3000 rpm and concentrate the sample to 400 µl
2. Add 5~10 µl Proteinase K (10 mg/ml) to the sample. Vortex for 5 seconds to mix sample.
3. Incubate at 56°C for 10 minutes until the sample lysate is clear. During incubation, invert the tube every 3 minutes.
4. Pipet 10 µl Carrier RNA (1 mg/ml) into the MagCore® Sample Tubes.
5. Put the prepared Sample Tube into the W1 of T-Rack.
6. Put Elution Tube into the W5 of T-Rack and Pipette Tip into the W3 of T-Rack.
7. Run Code **203** (HF16, Compact) or **203A/203B** (Super, HF16 Plus) program at MagCore®.

## Swab Protocol

### \*Not Provided: GT Buffer and Filter Column Set.

1. Separate the swab cotton from the stick. Place the swab into a 2 ml microcentrifuge tube, add 500 µl or more GT buffer (not provided, Cat. No. S44050030, 30 ml) and 20 µl Proteinase K (10 mg/ml).
2. Incubate the sample lysate at 55°C for 30 min.  
For Buccal Swab sample, donor should not ingest anything for at least 30 min prior to sample collection.
3. If there are any insoluble residues in the tube, transfer the supernatant to Filter Column (not provided, Cat. No. S42030001, 100 pcs; Cat No. S42030002, 36 pcs) and centrifuge at full speed for 5 mins to get clear tissue solution in the Collection Tube.
4. Pipette 400 µl of clear tissue solution and 10 µl Carrier RNA (1 mg/ml) to the MagCore® Sample Tube.
5. Put the prepared Sample Tube into the W1 of T-Rack.
6. Put Elution Tube into the W5 of T-Rack and Pipette Tip into the W3 of T-Rack.
7. Run Code **203** (HF16, Compact, Plus II) or **203A/203B** (Super, HF16 Plus) program at MagCore®.

## **Respiratory Sample Protocol (Sputum)**

### **Reagents to Be Prepared by User**

*Either Sputasol solution (not provided) or NAC buffer (not provided)*

1. *Liquefy the sample following either step a. or b.*
  - a. *Add 1 volume of Sputasol solution to 1 volume of sample and shake. Incubate in water bath at 37°C and shake periodically until the sample is completely liquefied.*
  - b. *Mix 1 volume of sample with 1 volume of NAC buffer (10 g N acetylcysteine per liter of 0.9% NaCl solution). If the sample is very viscous solid, disrupt it mechanically by pipetting up and down. Incubate at room temperature for 30 min and shake periodically until completely liquefied.*

*Note: if the sample is very viscous/solid, a longer incubation time with periodical shaking might be required.*

2. *Centrifuge the liquefied sample until pellet is obtained, then transfer the clear supernatant to a clean tube.*
3. *Apply 200µl or 400µl of clear lysate and continue with MagCore Viral Kit general protocol step 1 (Carrier RNA and PK step).*

## – Install Tube, Tip

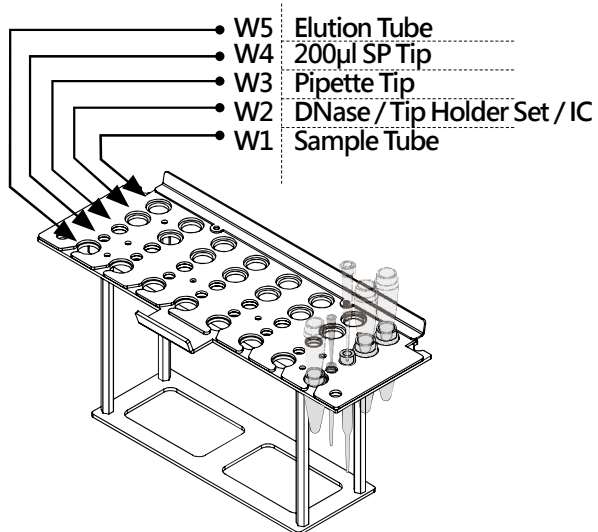

1. Put the tip into the corresponding well according to the left figure.
2. Put the T-Rack on the machine.

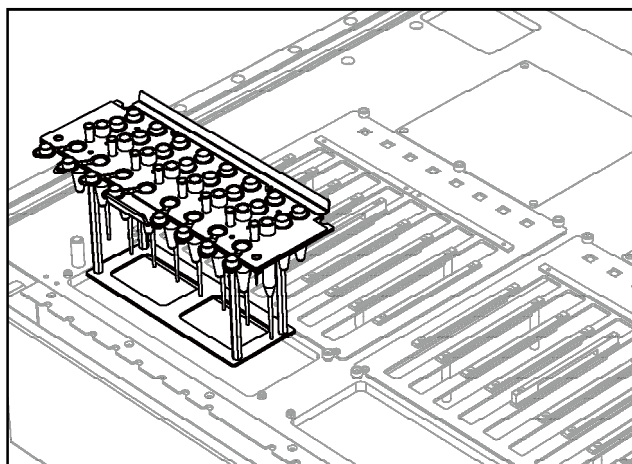

### Warning :

Please do not use the Tips and Tubes which are not provided by the original manufacturer. The test result may be not correct and the machine may be damaged due to different Tips and Tubes.

## MagCore® Viral Nucleic Acid Large Volume Extraction Kit (2.4 ml)

For extraction of viral DNA/RNA from large volume (2.4 ml) serum, plasma and cell-free body fluids.

Applicable Models : HF16, Compact

### Cartridge Code 210

Cat.No. MVN2400 (HF16, Compact)

#### Kit Contents

Check that the following parts are included in addition to the main unit:

**Cat.No. MVN2400 Contents:**

Pre-filled Cartridge Reagent.....	96 pcs.
Pipet Tip plus Holder Set.....	100 sets.
5ml Sample Tube.....	100 pcs.
Elution Tube.....	100 pcs.
Carrier RNA(1mg).....	2 pcs.
RNase Free Water.....	2 pcs.
Proteinase K(11mg).....	4 pcs.
PK Storage Buffer.....	4 pcs.

#### Storage and Stability:

1. This kit should be stored at room temperature.
2. Carrier RNA should be stored at -20°C when mixing with RNase Free Water.
3. Proteinase K should be stored at 2-8°C upon arrival.
4. Shelf Life: 18 Months.

#### Cartridge Contents:

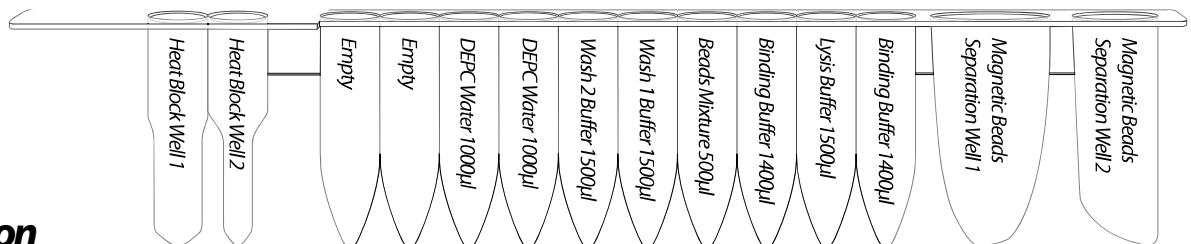

#### Description

MagCore® Viral Nucleic Acid Large Volume Extraction Kit (2.4ml) is designed for purification of DNA and RNA from 2.4ml serum, plasma, cell-free body fluids by MagCoreR auto-extraction instrument. With all the kit components of plastic consumables that are DNase/ RNase-Free pretreated, and with individual processing track for each loaded sample, this system eliminates all possible cross contamination between samples. Built-in protocol with flexibility in sample source volumes, both DNA and RNA virus can be extracted using the same kit in a fast and economical way.

#### Applications

Using magnetic-particle technology to purify viral nucleic acid from serum, plasma, or cell-free body fluids. The purified viral nucleic acid is suitable for highly sensitive and quantitative PCR.

### **Preparation before using**

1. Add 1.0 ml RNase Free Water to the Carrier RNA tube and mix by vortexing. Store prepared Carrier RNA (1 mg/ml) at -20°C.  
(Do not freeze–thaw the carrier RNA more than 3 times.)
2. Add 1.1 ml PK Storage Buffer to the Proteinase K tube and mix by vortexing. Store prepared Proteinase K (10 mg/ml) at 2-8 °C

### **Protocol**

1. Pipet 20 µl Carrier RNA (1 mg/ml) and 40 µl proteinase K (10 mg/ml) into the 5 ml Sample Tubes (provided).
2. Add 2400 µl of serum, plasma, or cell-free body fluids into the prepared 5 ml Sample Tube.
3. Put the prepared 5 ml Sample Tube into the correct well of T-Rack. (see page 3-10)
4. Put Elution Tube and Tip Plus Holder Set (HF16, Compact) / Pipette Tip (Super, Plus) into the correct wells of the T-Rack. (see page 3-10)
5. Run Code 210 program at MagCore®.

## MagCore® Viral Nucleic Acid Large Volume Extraction Kit (1.2 ml)

For extraction of viral DNA/RNA from large volume (1.2 ml) serum, plasma and cell-free body fluids.  
Applicable Models : HF16, Compact, HF48, Super, HF16 Plus, Plus II

### Cartridge Code 211

Cat.No.MVN1200

#### Kit Contents

Check that the following parts are included in addition to the main unit:

**Cat.No. MVN1200 Contents:**

Pre-filled Cartridge Reagent.....	96 pcs.
Pipet Tip plus Holder Set.....	100 sets.
Sample Tube.....	100 pcs.
Elution Tube.....	100 pcs.
Carrier RNA(1mg).....	1 pcs.
RNase Free Water.....	1 pcs.
Proteinase K(11mg).....	2 pcs.
PK Storage Buffer.....	2 pcs.

#### Storage and Stability:

1. This kit should be stored at room temperature.
2. Carrier RNA should be stored at -20°C when mixing with RNase Free Water / Proteinase K should be stored at 2-8 °C upon arrival.
3. Shelf Life: 18 Months.

#### Cartridge Contents :

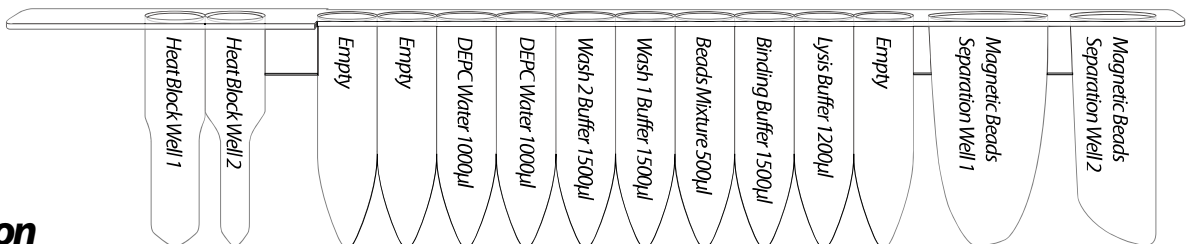

### Description

MagCore® Viral Nucleic Acid Large Volume Extraction Kit (1.2ml) is designed for purification of DNA and RNA from 1.2ml serum, plasma, cell-free body fluids by MagCoreR auto-extraction instrument. With all the kit components of plastic consumables that are DNase/ RNase-Free pretreated, and with individual processing track for each loaded sample, this system eliminates all possible cross contamination between samples. Built-in protocol with flexibility in sample source volumes, both DNA and RNA virus can be extracted using the same kit in a fast and economical way.

### Applications

Using magnetic-particle technology to purify viral nucleic acid from serum, plasma, or cell-free body fluids. The purified viral nucleic acid is suitable for highly sensitive and quantitative PCR.

**Preparation Before Using**

1. Add 1.0 ml RNase Free Water to the Carrier RNA tube and mix by vortexing. Store prepared Carrier RNA (1mg/ml) at -20°C. (Do not freeze–thaw the carrier RNA more than 3 times.)
2. Add 1.1 ml PK Storage Buffer to the Proteinase K tube and mix by vortexing. Store prepared Proteinase K (10mg/ml) at 2-8 °C

**Protocol**

1. Pipet 10 µl Carrier RNA(1mg/ml) and 20 µl proteinase K(10mg/ml) into the MagCore® Sample Tubes(provided).
2. Add 1200 µl of serum, plasma, or cell-free body fluids into the prepared Sample Tube.
3. Put the prepared Sample Tube into the correct well of T-Rack. (see page 3-10)
4. Put Elution Tube and Tip Plus Holder Set (HF16, Compact) / Pipette Tip (Super, Plus) into the correct wells of the T-Rack. (see page 3-10)
5. Run Code 211 program at MagCore®.

# MagCore® Genomic DNA Plant Kit

For extraction of genomic DNA from plant and fungal tissues.

Applicable Models : HF16, Compact, HF48, Super, HF16 Plus, Plus II

## Cartridge Code 301

Cat.No. MGP-01 // MGP-02

### Kit Contents

Check that the following parts are included in addition to the main unit:

#### Cat.No. MGP-01 Contents:

Pre-filled Cartridge Reagent.....	36 pcs.
Pipet Tip plus Holder Set.....	36 sets.
Sample Tube.....	36 pcs.
Elution Tube.....	36 pcs.
Filter Column Set.....	36 pcs.
RNase A(10mg/ml, 275µl).....	1 pcs.
GP1 Buffer(25ml).....	1 pcs.
GP2 Buffer(6ml).....	1 pcs.

#### Cat.No. MGP-02 Contents:

Pre-filled Cartridge Reagent.....	96 pcs.
Pipet Tip plus Holder Set.....	100 sets.
Sample Tube.....	100 pcs.
Elution Tube.....	100 pcs.
Filter Column Set.....	100 pcs.
RNase A(10mg/ml, 550µl).....	1 pcs.
GP1 Buffer(50ml).....	1 pcs.
GP2 Buffer(15ml).....	1 pcs.

#### Storage and Stability:

1. This kit should be stored at room temperature.
2. For long term storage, RNase A should be stored at 2-8 °C.
3. Shelf Life: 18 Months.

#### Cartridge Contents:

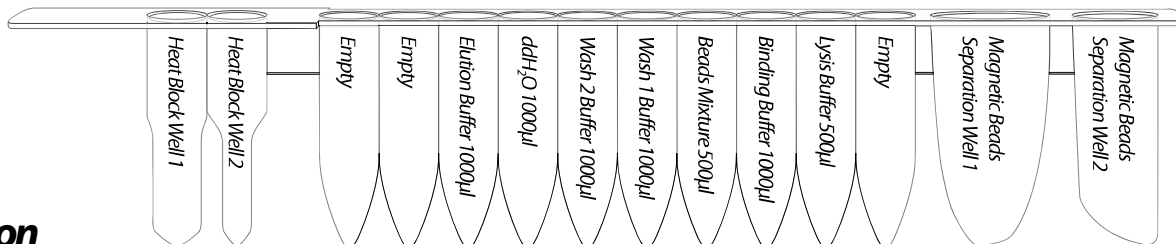

## Description

MagCore® Genomic DNA Plant Kit is designed for purification of DNA from plant tissues and cells by using MagCore® autoextraction instrument. The provided Filter Column Set can filtrate hard tissue sample and prevent tissue residues to obstruct pipette tip during the process of MagCore®. The kit contains all required reagents and labware for automated purification using magnetic-particle technology. Easy select program code number 301 in MagCore® and combine using this kit that it can perform high quality genomic DNA.

## Applications

Using magnetic-particle technology to purify genomic DNA up to 100mg of fresh tissue. The purified genomic DNA can be directly used for downstream application such as quantitative PCR, PCR, southern blotting, RADP / AFLP, etc.



## Preparation Before Using

The kit procedures are optimized for a maximum of 100 mg of wet-weight or 20 mg of dried starting material.

Exceeding the recommended maximum amount of starting material will result in inefficient lysis, resulting in low yield and purity.

## Tissue Dissociation Protocol

1. Cut 50 mg (up to 100 mg) of fresh or frozen plant tissue or 5 mg (up to 20 mg) of dried sample.
2. Grind the sample with mortar and pestle under liquid nitrogen to a fine powder. For some plant samples, liquid nitrogen may be unnecessary for homogenization.
3. Transfer it into a microcentrifuge tube (not provided).

### Lysis Step:

1. Add 400µl GP1 Buffer and 5µl RNase A (10mg/ml) into the microcentrifuge tube and mix by vortexing. Do not mix GP1 Buffer with RNase A before use.
2. Incubate at 65°C for 10 minutes. During incubation, invert the tube every 5 minutes.
3. Add 100µl GP2 Buffer and mix by vortexing.
4. Incubate on ice for 3 minutes. Place a Filter Column into a 2 ml Collection Tube and apply the entire lysate from previous step to the Filter Column.
5. Centrifuge for 3 minutes at full speed (13,000 rpm).
6. Discard the Filter Column and carefully transfer clarified lysate (about 400µl) in the collection Tube to the MagCore® Sample Tubes
7. Put the prepared Sample Tube into the correct well of T-Rack. (see page 3-10)
8. Put Elution Tube and Tip Plus Holder Set (HF16, Compact) / Pipette Tip (Super, Plus) into the correct wells of the T-Rack. (see page 3-10)
9. Run Code 301 program at MagCore®.

## Fungal Tissue Protocol

### Sample Preparation

1. Collect the fungal tissue up to 20 mg.
2. Grind the sample with mortar and pestle under liquid nitrogen to a fine powder.
3. Transfer it into a microcentrifuge tube (not provided). Do not allow the sample to thaw.

### Cell Lysis

1. Add 400µl GP1 Buffer and 5µl RNase A (10mg/ml) into the microcentrifuge tube and mix by vortexing. Do not mix GP1 Buffer with RNase A before use.
2. Incubate at 65°C for 10 minutes. During incubation, invert the tube every 5 minutes.
3. Add 100µl GP2 Buffer and mix by vortexing.
4. Incubate on ice for 3 minutes. Place a Filter Column into a 2 ml Collection Tube and apply the entire lysate from previous step to the Filter Column.
5. Centrifuge for 3 minutes at full speed (13,000 rpm).
6. Discard the Filter Column and carefully transfer clarified lysate (about 400µl) in the collection Tube to the MagCore® Sample Tubes.
7. Put the prepared Sample Tube into the correct well of T-Rack. (see page 3-10)
8. Put Elution Tube and Tip Plus Holder Set (HF16, Compact) / Pipette Tip (Super, Plus) into the correct wells of the T-Rack. (see page 3-10)
9. Run Code 301 program at MagCore®.

## MagCore® Genomic DNA Tissue Kit

For extraction of genomic DNA from a variety to animal tissues, paraffin-embedded tissue, swab, blood stain, forensic specimens and cultured yeast.

Applicable Models : HF16, Compact, HF48, Super, HF16 Plus, Plus II

### Cartridge Code 401

Cat.No. MGT-01 // MGT-02

#### Kit Contents

Check that the following parts are included in addition to the main unit:

##### Cat.No. MGT-01 Contents:

Pre-filled Cartridge Reagent.....	36 pcs.
Pipet Tip plus Holder Set.....	36 sets.
Sample Tube.....	36 pcs.
Elution Tube.....	36 pcs.
GT Buffer(30ml).....	1 pcs.
Filter Column Set.....	36 pcs.
Proteinase K(11mg).....	1 pcs.
PK Storage Buffer.....	1 pcs.

##### Cat.No. MGT-02 Contents:

Pre-filled Cartridge Reagent.....	96 pcs.
Pipet Tip plus Holder Set.....	100 sets.
Sample Tube.....	100 pcs.
Elution Tube.....	100 pcs.
GT Buffer(30ml).....	2 pcs.
Filter Column Set.....	100 pcs.
Proteinase K(11mg).....	2 pcs.
PK Storage Buffer.....	2 pcs.

#### Storage and Stability:

1. This kit should be stored at room temperature.
2. Proteinase K should be stored at 2-8 °C upon arrival.
3. Shelf Life: 18 Months.

#### Cartridge Contents:

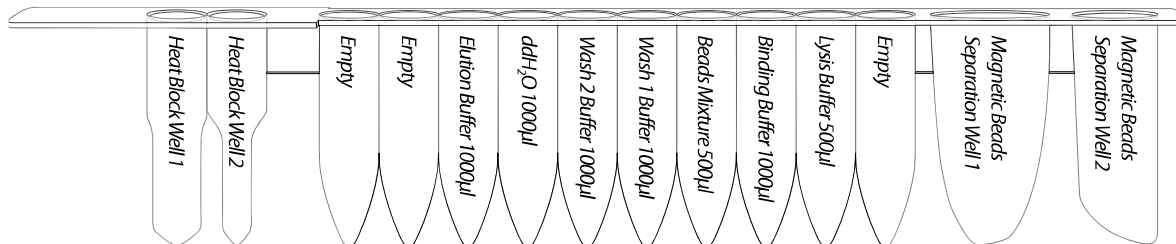

## Description

MagCore® Genomic DNA Tissue Kit is designed for purification of total DNA (including genomic, mitochondrial and viral DNA) from a variety of animal tissues or cells by using MagCore® auto-extraction instrument. The provided Filter Column can filtrate hard tissue sample or swab sample to prevent tissue residues to obstruct pipette tip during the process of MagCore®. The method uses pre-filled cartridge which contains proteinase K and a chaotropic salt to lyse cells and degrade protein. DNA will bind to cellulose coated Magnetic Beads. After washing off the contaminants, the purified DNA is eluted by low salt elution buffer. Purified DNA of approximately 20-30 kb in length is suitable for PCR or other enzymatic reactions.

## Applications

Using magnetic-particle technology to purify genomic DNA from animal tissues, paraffin embedded tissue, swab and blood stain. The purified genomic DNA can be directly used for downstream application such as quantitative PCR, restriction enzyme digestion, southern blotting, etc.

## Preparation Before Using

1. Add 1.1 ml PK Storage Buffer to the Proteinase K tube and mix by vortexing. Store prepared Proteinase K (10 mg/ml) at 2-8 °C

## For Paraffin-Embedded Tissue

### Sample Preparation:

*Additional Requirements: Xylene (or Substitutes), Ethanol (96-100%), Microcentrifuge Tube.*

*Suggested Xylene Substitute: A5597 (Sigma), Neo-Clear (Merck), CitriSolv (Fisher).*

1. Slice small section (5-10 µm) of paraffin-embedded tissue and transfer to a microcentrifuge tube.  
*Discard the first 2-3 sections, if the surface of paraffin sample has been exposed to air.*
2. Add 1 ml xylene (or substitute) to the tube and vortex vigorously for 10 sec. Then incubate at 60 °C for 10 min.
3. Centrifuge at full speed for 3 min at room temperature.
4. Remove the supernatant carefully by pipetting, then add 1 ml ethanol (96-100%) to the pellet and mix by vortexing for 10 sec.
5. Centrifuge at full speed for 5 min at room temperature.
6. Remove the supernatant carefully by pipetting, then add again of 1 ml ethanol (96-100%) to the pellet and mix by vortexing for 10 sec to wash again.
7. Centrifuge at full speed for 5 min.
8. Remove residual ethanol with a fine pipette tip, then open the tube and incubate at 55 °C for 5 min until all residual ethanol has been evaporated.
9. Add 400 µl GT Buffer and 20 µl Proteinase K (10 mg/ml) to the tube and mix by vortexing.
10. Incubate at 55 °C for 90 min until the sample has been completely lysed.
11. If there are any insoluble residues in the tube, transfer the supernatant to Filter Column and centrifuge at full speed for 5 min to get clear tissue solution in the Collection Tube.
12. Pipette 400 µl of clear tissue solution to the MagCore® Sample Tube.
13. Put the prepared Sample Tube into the correct well of T-Rack. (see page 3-10)
14. Put Elution Tube and Tip Plus Holder Set (HF16, Compact) / Pipette Tip (Super, Plus) into the correct wells of the T-Rack. (see page 3-10)
15. Run Code 401 program at MagCore®.

## For Swab Sample

### Additional Requirements: PBS and Microcentrifuge Tube.

1. Separate the swab cotton from the stick. Place the swab into a 2 ml microcentrifuge tube, add 500 µl or more of GT Buffer and 20 µl Proteinase K (10 mg/ml).
2. Incubate the sample lysate at 55 °C for 30 min.  
*For Buccal Swab sample, donor should not ingest anything for at least 30 min prior to sample collection.*
3. If there are any insoluble residues in the tube, transfer the supernatant to Filter Column and centrifuge at full speed for 5 min to get clear tissue solution in the Collection Tube.
4. Pipette 400 µl of clear tissue solution to the MagCore® Sample Tube.
5. Put the prepared Sample Tube into the correct well of T-Rack. (see page 3-10)
6. Put Elution Tube and Tip Plus Holder Set (HF16, Compact) / Pipette Tip (Super, Plus) into the correct wells of the T-Rack. (see page 3-10)
7. Run Code 401 program at MagCore®.

## For Solid Animal Tissue

### **Additional Requirements: Microcentrifuge Tube.**

1. Cut the solid tissue to small pieces (up to 30 mg) and put into a microcentrifuge tube.
2. Add 400µl GT Buffer and 20µl Proteinase K (10mg/ml) to the tube and mix by vortexing.
3. Incubate at 55°C for 90min until the sample has been completely lysed.
4. If there are any insoluble residues in the tube, transfer the supernatant to Filter Column and centrifuge at full speed for 5min to get clear tissue solution in the Collection Tube.
5. Pipette 400µl of clear tissue solution to the MagCore® Sample Tube.
6. Put the prepared Sample Tube into the correct well of T-Rack. (see page 3-10)
7. Put Elution Tube and Tip Plus Holder Set (HF16, Compact) / Pipette Tip (Super, Plus) into the correct wells of the T-Rack. (see page 3-10)
8. Run Code 401 program at MagCore®.

## For Stool Sample

### **Additional Requirements: Microcentrifuge Tube.**

1. Weight 180-200mg stool in a 2ml microcentrifuge tube and place on ice. If the sample is liquid, pipet 200µl into microcentrifuge tube. Cut the end of pipet tip to make pipetting easier. If the sample is frozen, use a scalpel or spatula to scrape bits of stool into microcentrifuge tube on ice.  
*Recommend Step: Add 1ml TE buffer (10 mM Tris -Cl; 1 mM EDTA, pH 8). Resuspend the sample by vigorous vortexing for 30 secs. Centrifuge the sample mixture for 15 min at 4,000xg and discard supernatant.*
2. Add 1.5ml GT Buffer to sample. Vortex continuously for 1 min or until the stool sample is thoroughly homogenized. This is very important to vortex sample thoroughly to ensure maximum DNA concentration in the final elutes.
3. Incubate the suspension for 5 min at 70°C. This step can increase DNA recovery 3-5 fold, if the sample target is Gram-positive bacteria, please increase to 95°C for cells lysis.
4. Vortex for 15 seconds and centrifuge sample at full speed (13,000rpm) for 1 min to pellet stool particles.
5. Pipet 400µl of the supernatant into a new 1.5ml microcentrifuge tube.
6. Add 20µl Proteinase K (10mg/ml) to the sample mixture and vortex to mix. Incubate at 60°C for 2~3 hours to lyse the sample.
7. If there are any insoluble residues in the tube, transfer the supernatant to Filter Column and centrifuge at full speed for 5min to get clear tissue solution in the Collection Tube.
8. Pipette 400µl of clear tissue solution to the MagCore® Sample Tube.
9. Put the prepared Sample Tube into the correct well of T-Rack. (see page 3-10)
10. Put Elution Tube and Tip Plus Holder Set (HF16, Compact) / Pipette Tip (Super, Plus) into the correct wells of the T-Rack. (see page 3-10)
11. Run Code 401 program at MagCore®.

### For Feed-Soil Sample

1. Apply 30~40mg feed or soil samples into a 1.5 ml microcentrifuge tube.
2. Add 20µl (10mg/ml) Proteinase K and followed by adding 500µl of GT Buffer. Vortex gently until the powder suspend in GT buffer.
3. Incubate the mixture at 56°C for 15mins. Invert the tube every 2~3mins during incubation.  
Typically 15mins incubation can lysis more than 90% cells. Extend incubation time to 20mins can increase 10% of yield.
4. Centrifuge the mixture for 3 min at full speed.
5. If there are any insoluble residues in the tube, transfer the supernatant to Filter Column and centrifuge at full speed for 5min to get clear tissue solution in the Collection Tube.
6. Pipette 400µl of clear tissue solution to the MagCore® Sample Tube.
7. Put the prepared Sample Tube into the correct well of T-Rack. (see page 3-10)
8. Put Elution Tube and Tip Plus Holder Set (HF16, Compact) / Pipette Tip (Super, Plus) into the correct wells of the T-Rack. (see page 3-10)
9. Run Code 401 program at MagCore®.

### For Dried Blood Spot

1. Cut 3mm diameter punches from a dried blood spot with a single-hole paper punch. Place up to 3 blood card into a 1.5ml microcentrifuge tube.
2. Add 400~500µl GT buffer into the microcentrifuge tube and continue to homogenize the sample tissue with grinding.
3. Add 20µl Proteinase K (10mg/ml) to the sample mixture and vortex to mix. Incubate at 60°C for 1 hour to lyse the sample.
4. If there are any insoluble residues in the tube, transfer the supernatant to Filter Column and centrifuge at full speed for 5min to get clear tissue solution in the Collection Tube.
5. Pipette 400µl of clear tissue solution to the MagCore® Sample Tube.
6. Put the prepared Sample Tube into the correct well of T-Rack. (see page 3-10)
7. Put Elution Tube and Tip Plus Holder Set (HF16, Compact) / Pipette Tip (Super, Plus) into the correct wells of the T-Rack. (see page 3-10)
8. Run Code 401 program at MagCore®.

### Optional Step: RNA Degradation

*If RNA-Free genomic DNA is required, perform these optional steps before adding Proteinase K.*

1. Add 4µl RNase A (not provided, 50mg/ml) into the sample lysate.
2. Incubate the sample at room temperature for 20min.

## **Cigarette Butts Protocol**

### **Sample Preparation**

1. Cut 1 cm<sup>2</sup> piece of outer paper from the end of the cigarette or filter. Cut this piece into 6 smaller pieces. Transfer the pieces to a 1.5 ml microcentrifuge tube.

### **Cell Lysis**

1. Add 500µl GT buffer and 20µl Proteinase K, close the lid, and mix for 10 sec. Incubate at 60°C for 1 hour to lyse the sample.
2. Briefly centrifuge the tube to remove drops from the inside of the lid.
3. Pipette 400µl of clear tissue solution to the MagCore® Sample Tube.
2. Put the prepared Sample Tube into the correct well of T-Rack. (see page 3-10)
3. Put Elution Tube and Tip Plus Holder Set (HF16, Compact) / Pipette Tip (Super, Plus) into the correct wells of the T-Rack. (see page 3-10)
4. Run Code 401 program at MagCore®.

## **Hair Roots Protocol**

### **Sample Preparation**

1. Cut the hair roots into 0.5–1 cm pieces, and transfer them to the 1.5 ml microcentrifuge tube.

### **Cell Lysis**

1. Add 500µl GT buffer and 20µl Proteinase K, close the lid, and mix for 10 sec. Incubate at 60°C for 1 hour to lyse the sample.
2. Briefly centrifuge the tube to remove drops from the inside of the lid.
3. Pipette 400µl of clear tissue solution to the MagCore® Sample Tube.
4. Put the prepared Sample Tube into the correct well of T-Rack. (see page 3-10)
5. Put Elution Tube and Tip Plus Holder Set (HF16, Compact) / Pipette Tip (Super, Plus) into the correct wells of the T-Rack. (see page 3-10)
6. Run Code 401 program at MagCore®.

## Chewing Gum Protocol

### Sample Preparation

1. Cut up to 30 mg of chewing gum into small pieces and transfer them to a 1.5 ml microcentrifuge tube.

### Cell Lysis

1. Add 500µl GT buffer and 20µl Proteinase K, close the lid, and mix for 10 sec. Incubate at 60°C for 1~3 hours to lyse the sample.
2. Briefly centrifuge the tube to remove drops from the inside of the lid.
3. Pipette 400µl of clear tissue solution to the MagCore® Sample Tube.
4. Put the prepared Sample Tube into the correct well of T-Rack. (see page 3-10)
5. Put Elution Tube and Tip Plus Holder Set (HF16, Compact)/Pipette Tip (Super, Plus) into the correct wells of the T-Rack. (see page 3-10)
6. Run Code 401 program at MagCore®.

## Betel Nut Residue Protocol

### Sample Preparation

1. Cut up to 30 mg of betel nut residue into small pieces and transfer them to a 1.5 ml microcentrifuge tube.

### Cell Lysis

1. Add 500µl GT buffer and 20µl Proteinase K, close the lid, and mix for 10 sec. Incubate at 60°C for 1~3 hours to lyse the sample.
2. Briefly centrifuge the tube to remove drops from the inside of the lid.
3. Pipette 400µl of clear tissue solution to the MagCore® Sample Tube.
4. Put the prepared Sample Tube into the correct well of T-Rack. (see page 3-10)
5. Put Elution Tube and Tip Plus Holder Set (HF16, Compact)/Pipette Tip (Super, Plus) into the correct wells of the T-Rack. (see page 3-10)
6. Run Code 401 program at MagCore®.

## Saliva Protocol

### Sample Preparation

1. For saliva sample, donor should not ingest anything for at least 30min prior to sample collection.
2. Prepare PBS Buffer and 15 ml tube.

### Cell Lysis

1. Apply the 1 ml saliva and add 4 ml PBS buffer (not provided).
2. Centrifuge at 1800xg for 5 min, and then carefully discard the supernatant.
3. Resuspend the pellet in 400µl GT buffer.
4. Add 20µl Proteinase K, close the lid, and mix for 10 sec. Incubate at 70°C for 10 minutes to lyse the sample.
5. If there are any insoluble residues in the tube, transfer the supernatant to Filter Column and centrifuge at full speed for 5min to get clear tissue solution in the Collection Tube.
6. Pipette 400µl of clear tissue solution to the MagCore® Sample Tube.
7. Put the prepared Sample Tube into the correct well of T-Rack. (see page 3-10)
8. Put Elution Tube and Tip Plus Holder Set (HF16, Compact)/Pipette Tip (Super, Plus) into the correct wells of T-Rack. (see page 3-10)
9. Run Code 401 program at MagCore®.



## Cultured Yeast Protocol

- **Additional requirements:** Sorbitol Buffer, Lyticase or Zymolase, Microcentrifuge tube.
- **Preparation of Sorbitol Buffer:**

1.2M sorbitol, 10mM CaCl<sub>2</sub>, 0.1M Tris-Cl pH7.5. Sterilize by filtration and store at 2-8 °C

### Sample Preparation

1. Harvest 3ml yeast cells (up to  $5 \times 10^7$  cells) by centrifugation at 5000 x g for 10 minutes. Discard the supernatant and carefully remove any remaining media by aspiration.
2. Resuspend the cell pellet in 600µl sorbitol buffer (not provided).

### Cell Lysis

1. Add 200U Lyticase or Zymolase (not provided). Incubate at 30°C for 30 minutes. Centrifuge the mixture for 10 min at 2,000 x g to harvest Spheroplast.
2. Remove the supernatant and add 400µl of GT Buffer to the tube and vortex or pipette to resuspend the cell pellet.
3. Incubate at 55°C for 90min until the sample has been completely lysed.
4. If there are any insoluble residues in the tube, transfer the supernatant to Filter Column and centrifuge at full speed for 5 min to get clear tissue solution in the collection tube.
5. Pipette 400µl of clear tissue solution to the MagCore® Sample Tube.
6. Put the prepared Sample Tube into the correct well of T-Rack. (see page 3-10)
7. Put Elution Tube and Tip Plus Holder Set (HF16, Compact) / Pipette Tip (Super, Plus) into the correct wells of the T-Rack. (see page 3-10)
8. Run Code 401 program at MagCore®.

## MagCore® Genomic DNA FFPE One-Step Kit

For extraction of total DNA from formalin-fixed paraffin-embedded (FFPE) tissue by using MagCore® System.  
**Applicable Models : HF16, Compact, HF48, Super, HF16 Plus, Plus II**

### Cartridge Code 405

Cat. No. MGF-01 // MGF-03

#### Kit Contents

Check that the following parts are included in addition to the main unit:

##### Cat.No. MGF-01 Contents:

Pre-filled Cartridge Reagent.....	36 pcs.
Pipet Tip plus Holder Set.....	72sets.
Elution Tube.....	36 pcs.
Sula Oil (25 ml).....	1 pcs.
Proteinase K(11mg).....	1 pcs.
PK Storage Buffer.....	1 pcs.
Thermostable Cap .....	36 pcs.

##### Cat.No. MGF-03 Contents:

Pre-filled Cartridge Reagent.....	72 pcs.
Pipet Tip plus Holder Set.....	150 sets.
Elution Tube.....	75 pcs.
Sula Oil (50ml).....	1 pcs.
Proteinase K(11mg).....	2 pcs.
PK Storage Buffer.....	2 pcs.
Thermostable Cap .....	75 pcs.

#### Storage and Stability:

1. This kit should be stored at room temperature.
2. Proteinase K should be stored at 2-8 °C upon arrival.
3. Shelf Life: 18 Months.

#### Cartridge Contents :

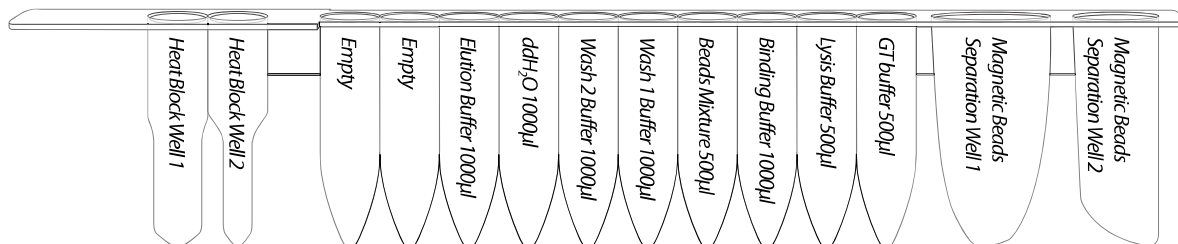

## Description

MagCore® Genomic DNA FFPE One-Step Kit is designed for purification of total DNA from FFPE tissues by using MagCore® instruments. It features the method, One-Step Heating, to melt paraffin and lyse tissue samples at the same time without harmful reagents involved such as xylene. Two protocols are designed and optimized for different sizes of tissues: 2 hrs for small samples/ 16 hrs for large samples (Please see "important notes"). DNA will be extracted fast and economically based on the cellulose coated magnetic bead technology.

## Applications

Use magnetic-particle technology to purify genomic DNA from FFPE tissue. The purified genomic DNA can be directly used for downstream application such as PCR, real-time PCR, restriction enzyme digestion, southern blotting, etc.

## Preparation Before Using

1. Add 1.1 ml PK Storage Buffer to the Proteinase K tube and mix by vortexing. Store prepared Proteinase K (10 mg/ml) at 2-8°C

## For Needle-Like FFPE Tissue Slices

1. Add 500 µl Sula Oil, 20 µl PK and the FFPE tissue sample to the bottom of Heat Block Well 1 of the cartridge and then cover it up with the Thermostable Cap.

**Note:** If the tissue is too large to lyse (the surface area over 300 mm<sup>2</sup>), cut it in 4 sections (Please see "important notes step 3") before adding in the heat block well 1 would be suggested. Make sure the tissue is at the bottom of the well to avoid clipping it by Thermostable cap.

2. Put Elution Tube and Tip Plus Holder Set (HF16, Compact)/Pipette Tip (Super, Plus) into the correct wells of the T-Rack. (see page 3-10)
3. Run Code 405 program at MagCore®.

## For Glass-Slide Samples

1. Drop several Sula Oil on the glass slide and scrape them from the slide carefully, then put in the bottom of Heat Block Well 1.
2. Add 500 µl Sula Oil and 20 µl PK into Heat Block well 1, rinse remaining sample on the wall and blade, then cover it up with the Thermostable Cap.
3. Put Elution Tube and Tip Plus Holder Set (HF16, Compact)/Pipette Tip (Super, Plus) into the correct wells of the T-Rack. (see page 3-10)
4. Run Code 405 program at MagCore®.

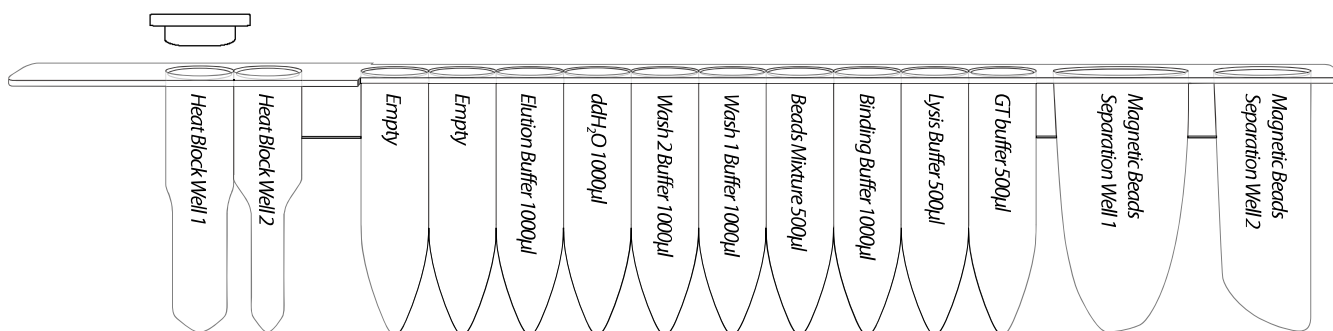

MagCore® Super/MagCore® HF16 Plus

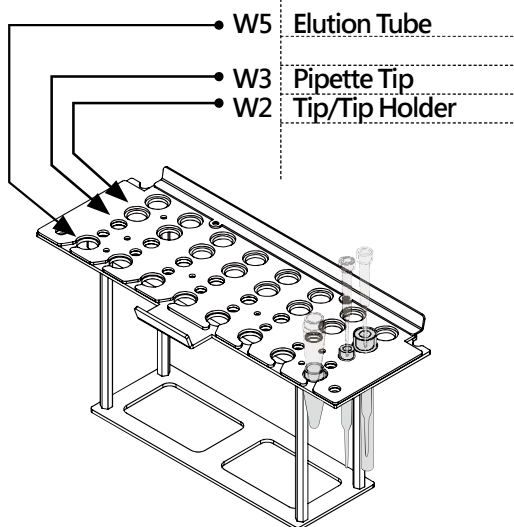

MagCore® HF16/MagCore® Compact

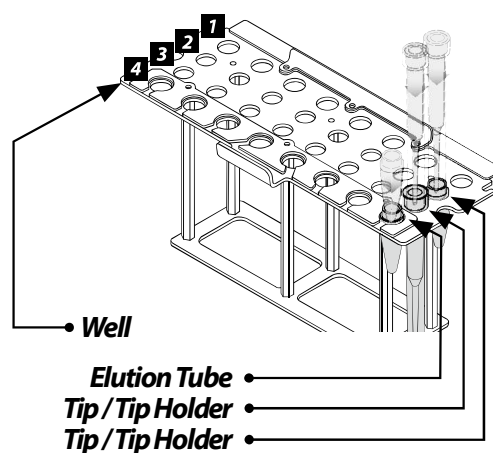

## Important Notes

1. The surface area of the FFPE tissue sample could be measured as following examples:

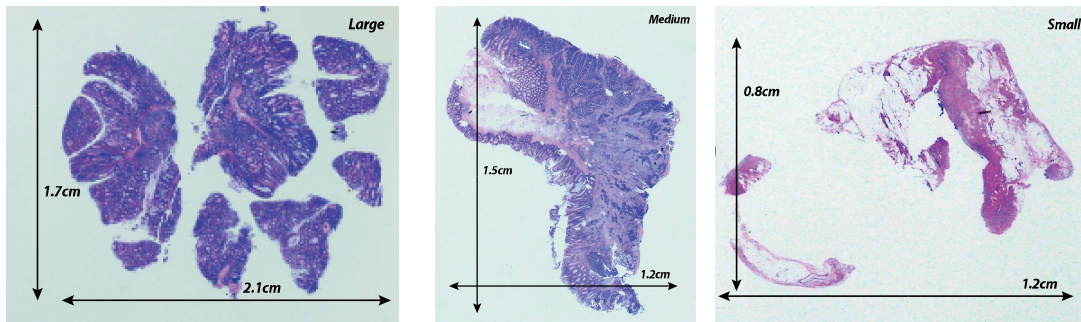

2. Sample amount of preparation can be 1-5 scrolls, each with a thickness up to 5 $\mu$ m. One FFPE scroll could be enough to analyze if the surface area is over 200mm<sup>2</sup>.

Surface Area (mm <sub>2</sub> )	Sample Scroll
200 ↑	1
100-200	1-2
50-100	2-3
50 ↓	3-5

(Don't over load 5 scrolls)

\*Overloading the sample or paraffin will clog the tip and decrease the yield.

3. If the tissue sample is over 300mm<sup>2</sup>, we recommend cutting it into 4 sections as following examples:



4. If you have no information about the sample, we recommend starting with no more than 1 scroll and cutting it into 4 sections per preparation.

5. Sula Oil is a deparaffin buffer. The capacity of the Sula Oil (500 $\mu$ l) is about 20 mg paraffin per preparation.

6. In MagCore<sup>®</sup>405 program, two different lyse time are provided: 2hr and 16hr.

## Remarks

1. Both 2hr and 16hr program can extract DNA from FFPE sample.

Choose 2hr program for saving time; choose 16hr for higher yield.

2. If you want to increase DNA yield, an overnight incubation (16hr program) can be performed, but it may result in greater DNA fragmentation.

## Troubleshooting

Symptoms	Comments and Suggestions
<i>Low or NO DNA product</i>	<ol style="list-style-type: none"> <li data-bbox="663 376 1455 443">1. <i>The sample was lysed insufficiently. Make sure the proteinase K was stored at -20 °C, and repeat the procedure using fresh PK.</i></li> <li data-bbox="663 454 1455 555">2. <i>The sample was too large to lyse completely. The large FFPE tissue was suggested cutting into 4 sections, and one scroll was enough for extraction. Clogging tip will affect the extraction process.</i></li> </ol>
<i>Poor PCR results</i>	<ol style="list-style-type: none"> <li data-bbox="663 658 1455 725">1. <i>Poor quality FFPE samples. Fixation condition can affect PCR performance, such as long-time storage in fixative.</i></li> <li data-bbox="663 736 1455 837">2. <i>DNA fragments. DNA purified from FFPE samples may be fragmented due to formalin fixation, so we suggest keeping amplicons as short as possible for PCR.</i></li> </ol>
<i>Clogging tip or liquid up to the tip filter</i>	<ol style="list-style-type: none"> <li data-bbox="663 943 1455 1043">1. <i>The sample was too large to pipetting. Large tissue clogged the tip would result the liquid up to the tip filter or the extraction cannot finish. We suggest cutting the tissue before adding in the Heat Block well 1.</i></li> <li data-bbox="663 1055 1455 1155">2. <i>The sample was too much to pipetting. Do not extract too much scrolls at a time. For large tissue, one scroll is enough for extraction; for small tissue, we suggest not over 20mg of FFPE.</i></li> </ol>

## MagCore® Forensic DNA Direct Kit

For extracting genomic DNA from forensic samples

Applicable Models: Super, HF16 Plus, Plus II

### Cartridge Code 406

Cat.No. MFC-03

#### Kit Contents

Check that the following parts are included in addition to the main unit:

##### Cat.No. MFC-03 Contents:

Pre-filled Cartridge Reagent.....	72 pcs.
Pipette Tip.....	75 pcs.
FS Tip.....	75 pcs.
200 µl SP Tip.....	75 pcs.
Elution Tube.....	75 pcs.
Proteinase K(11 mg).....	2 pcs.
PK Storage Buffer.....	2 pcs.
Carrier RNA(1 mg).....	1 pcs.
RNase Free Water.....	1 pcs.

#### Storage and Stability:

1. This kit should be stored at room temperature.
2. Carrier RNA should be stored at -20°C when mixing with RNase Free Water.
3. Proteinase K should be stored at 2-8°C upon arrival.
4. Shelf Life: 18 Months.

#### Cartridge Contents :

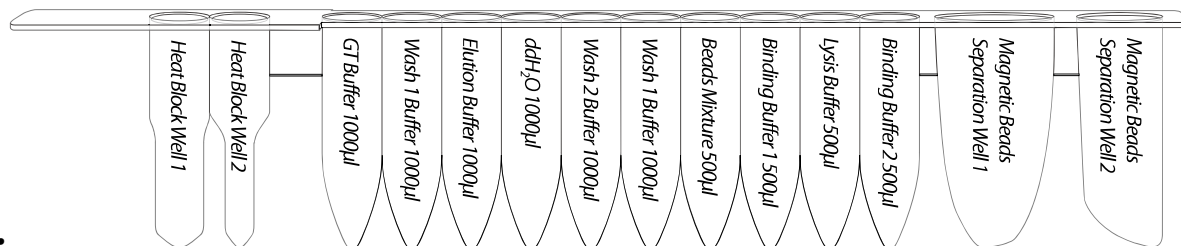

## Description

MagCore® Genomic DNA Forensic Kit is designed for purification of total DNA from forensic samples such as dried blood spot, swabs, cigarette butts, chewing gum, hair roots, seminal stain and nail clippings by using MagCoreR auto-extraction instrument. It features an automated method in which solid samples can be fully purified by the machine without any pre-treatments.

## Applications

The usage of magnetic-particle technology is to purify genomic DNA from forensic samples. The purified genomic DNA can be directly used for downstream applications such as STR, PCR, real-time PCR, restriction enzyme digestion, southern blotting, etc.

## Preparation Before Using

1. Add 1.0 ml RNase Free Water to the Carrier RNA tube and mix by vortexing. Store prepared Carrier RNA (1 mg/ml) at -20°C.
2. Add 1.1 ml PK Storage Buffer to the Proteinase K tube and mix by vortexing. Store prepared Proteinase K (10 mg/ml) at 2-8°C
3. Please confirm the software of the instrument is updated to the latest version by checking if the program code contains 406A, 406B and 406C from the cartridge number selection page, if not, please contact your local distributor.

## FS Tip Operation Steps



1. Take FS Tip out.
2. Unscrew the FS Tip lid.
3. Transfer the sample into the bottom of FS Tip.

**⚠ 4. Screw the lid moderately, not over tight to prevent tip deformation and leakage of liquid.**

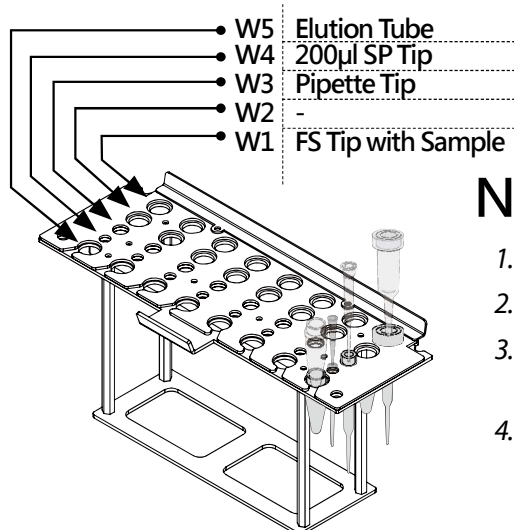

## Notes

1. Sample must be placed at the bottom of the FS Tip.
2. It is not recommended to perform the optical test for elution volumes of 30µl.
3. For the optical test, please make sure that the Magcore® Cuvettes are placed in the Cartridge Rack.
4. 5µl of Carrier RNA (1 mg/ml) and 20µl of proteinase K (10 mg/ml) must be added to the bottom of Heat Block Well1.



## Dried Blood Spot Protocol

### Sample Preparation

1. Punch 3mm-diameter holes from a dried blood spot with a single-hole paper punch. Place up to 3 punches into the bottom of FS Tip.
2. Add 5µl Carrier RNA (1mg/ml) and 20µl proteinase K (10mg/ml) to the bottom of Heat Block Well 1.
3. Put the 406 cartridges into Cartridge Rack.

Place the FS Tip (with Sample) into **well 1**, the Pipette Tip into **well 3**, the 200µl SP Tip into **well 4** and the Elution Tube into **well 5** of T-rack.

Run Code **406C** program at Magcore® Super/Plus.

## Swab Protocol

### Sample Preparation

1. Separate the swab cotton from its stick with scissors. Place the cotton at the bottom of the FS Tip.
2. Add 5µl Carrier RNA (1mg/ml) and 20µl proteinase K (10mg/ml) to the bottom of **Heat Block Well 1**.
3. Put the 406 cartridges into Cartridge Rack.
4. Place the FS Tip (with Sample) into **well 1**, the Pipette Tip into **well 3**, the 200µl SP Tip into **well 4** and the Elution Tube into **well 5** of T-rack.
5. For blood swab, run Code **406C** program at Magcore® Super; for saliva swab, run Code **406A** program at Magcore® Super/Plus.

## Cigarette Butts Protocol

### Sample Preparation

1. Cut off 0.5 cm thick of the filter with tipping paper from the filtration zone. Transfer a piece into the bottom of FS Tip.
2. Add 5µl Carrier RNA (1mg/ml) and 20µl proteinase K (10mg/ml) to the bottom of **Heat Block Well 1**.
3. Put the 406 cartridges into Cartridge Rack.
4. Place the FS Tip (with Sample) into **well 1**, the Pipette Tip into **well 3**, the 200µl SP Tip into **well 4** and the Elution Tube into **well 5** of T-rack.
5. Run Code **406B** program at Magcore® Super/Plus.

## Chewing Gum Protocol

### Sample Preparation

1. Cut off a piece of chewing gum (≤30mg). Transfer it into the bottom of FS Tip.
2. Add 5µl Carrier RNA (1mg/ml) and 20µl proteinase K (10mg/ml) to the bottom of **Heat Block Well 1**.
3. Put the 406 cartridges into Cartridge Rack.
4. Place the FS Tip (with Sample) into **well 1**, the Pipette Tip into **well 3**, the 200µl SP Tip into **well 4** and the Elution Tube into **well 5** of T-rack.
5. Run Code **406B** program at Magcore® Super/Plus.



## Hair Roots Protocol

### 1. ample Preparation

- Cut off 0.5-1 cm piece starting from the hair bulb and transfer it into the bottom of FS Tip.
- Add 5µl Carrier RNA (1mg/ml) and 20µl proteinase K (10mg/ml) to the bottom of **Heat Block Well 1**.
- Add 10µl DTT (1M) (not provided) to the bottom of **Heat Block Well 1**.
- Put the 406 cartridges into Cartridge Rack.
- Place the FS Tip (with Sample) into **well 1**, the Pipette Tip into **well 3**, the 200µl SP Tip into **well 4** and the Elution Tube into **well 5** of T-rack.
- Run Code **406B** program at Magcore® Super/Plus.

## Seminal Stain Protocol

### Sample Preparation

- Place a piece of stained fabric or tissue paper ( $\leq 0.5\text{cm}^2$ ) into the bottom of the FS Tip.
- Add 5µl Carrier RNA (1mg/ml) and 20µl proteinase K (10mg/ml) to the bottom of **Heat Block Well 1**.
- Add 10µl DTT (1M) (not provided) into Heat Block Well 1.
- Put the 406 cartridges into Cartridge Rack.
- Place the FS Tip (with Sample) into **well 1**, the Pipette Tip into **well 3**, the 200µl SP Tip into **well 4** and the Elution Tube into **well 5** of T-rack.
- Run Code **406C** program at Magcore® Super/Plus.

## Nail Clippings Protocol

### Sample Preparation

- Transfer the nail clippings ( $\leq 10\text{mg}$ ) into the bottom of FS Tip.
- Add 5µl Carrier RNA (1mg/ml) and 20µl proteinase K (10mg/ml) to the bottom of **Heat Block Well 1**.
- Add 10µl DTT (1M) (not provided) to the bottom of **Heat Block Well 1**.
- Put the 406 cartridges into Cartridge Rack.
- Place the FS Tip (with Sample) into **well 1**, the Pipette Tip into **well 3**, the 200µl SP Tip into **well 4** and the Elution Tube into **well 5** of T-rack.
- Run Code **406C** program at Magcore® Super/Plus.

## Selection Guide

Sample Program	Guthrie Card/Paper		Swab		Fabric		Cigarette Butt	Hair Root	Seminal Stain	Chewing Gum	Nail Clipping
	Blood	Saliva	Blood	Saliva	Blood	Saliva					
406A		■		■		■					
406B	□		□		□		■	■	□	■	
406C	■		■		■				■		■

■ : Recommended Program □ : Compatible Program

## MagCore® Genomic DNA Bacterial Kit

For extraction of genomic DNA from bacteria.

Applicable Models : HF16, Compact, HF48, Super, HF16 Plus, Plus II

### Cartridge Code 502

Cat.No.MBB-01//MBB-02

#### Kit Contents

Check that the following parts are included in addition to the main unit:

##### Cat.No. MBB-01 Contents:

Pre-filled Cartridge Reagent.....	36 pcs.
Pipet Tip plus Holder Set.....	36 sets.
Sample Tube.....	36 pcs.
Elution Tube.....	36 pcs.
Lysozyme Reaction Buffer(15ml).....	1 pcs.
Proteinase K(11mg).....	2 pcs.
PK Storage Buffer.....	2 pcs.
RNase A(50mg/ml, 160µl).....	1 pcs.

##### Cat.No. MBB-02 Contents:

Pre-filled Cartridge Reagent.....	96 pcs.
Pipet Tip plus Holder Set.....	100 sets.
Sample Tube.....	100 pcs.
Elution Tube.....	100 pcs.
Lysozyme Reaction Buffer(30ml).....	1 pcs.
Proteinase K(11mg).....	4 pcs.
PK Storage Buffer.....	4 pcs.
RNase A(50mg/ml, 400µl).....	1 pcs.

#### Storage and Stability:

1. This kit should be stored at room temperature.
2. Proteinase K should be stored at 2-8 °C upon arrival.
3. For long term storage, RNase A should be stored at 2-8 °C.
4. Shelf Life: 18 Months.

#### Cartridge Contents:

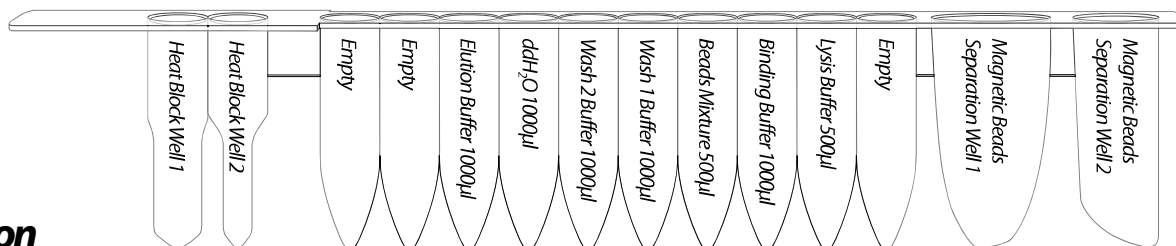

## Description

MagCore® Genomic DNA Bacterial kit is designed to extract genomic DNA from both Gram+ and Gram- bacteria via MagCore® auto-extraction instrument. The kit contains all required reagent and labware for automated purification using magnetic-particle technology. Easy select program code number 502 in MagCore® and combine using MagCore® Genomic DNA Bacterial Kit can extract high quality genomic DNA.

## Applications

Using magnetic-particle technology to purify genomic DNA from both Gram+ and Gram- bacteria. The purified genomic DNA can be directly used for downstream application such as quantitative PCR, restriction enzyme digestion, southern blotting, etc.

## Preparation Before Using

1. Add 1.1ml PK Storage Buffer to the Proteinase K tube and mix by vortexing. Store prepared Proteinase K (10mg/ml) at 2-8 °C
2. Freshly prepared 20mg/ml Lysozyme solution before use. (for Gram + bacteria isolation, Lysozyme solution is necessary)  
Lysozyme (not provided) + Lysozyme Reaction Buffer = Lysozyme Solution

## For Sputum Specimens

### Specimens Decontamination

1. Fresh prepare 0.5% NALC in 2% NaOH, 1.5% Na-Citrate solution.  
(Ex: 0.25g NALC in 50mL NALC-NaOH solution)
2. Mix 10mL specimen with 10mL NALC-NaOH sol'n, RT°C for 15 min.
3. Add 25mL PBS, mix and centrifuge 3000 x g for 15 min.
4. Discard supernatant, resuspend pellet with 200µl Lysozyme solution and transfer to the MagCore® Sample Tube.
5. Incubate for at least 30min at 37°C. During incubation, vortex the tube every 5min.

### Cell Lysis

1. Add 4µl RNase A (50mg/ml) to sample mixture(including any precipitate) and vortex to mix sample.
2. Incubate at room temperature for 10min.
3. Resuspend sample mixture by pipetting.
4. Adding 40µl Proteinase K(10mg/ml) to sample mixture and vortex to mix sample.
5. Put the prepared Sample Tube into the correct well of T-Rack. (see page 3-10)
6. Put Elution Tube and Tip Plus Holder Set (HF16, Compact)/Pipette Tip (Super, Plus) into the correct wells of the T-Rack. (see page 3-10)
7. Run Code 502 program at MagCore®.

## General Protocol

1. Harvest bacteria (maximum  $5 \times 10^6$  cells) into the MagCore® Sample Tube by centrifuging at 5000 x g(8000rpm) for 3min. Discard supernatant.
2. Resuspend bacterial pellet in 200µl Lysozyme Solution by vortexing or pipetting. (if target is Gram- bacteria, please use Lysozyme Reaction Buffer)
3. Incubate for at least 30min at 37°C and vortex the tube every 5min. (for Gram- bacteria isolation, you can skip this step)
4. Add 4µl RNase A (50mg/ml) to sample mixture(including any precipitate) and vortex to mix sample.
5. Incubate at room temperature for 10min.
6. Resuspend sample mixture by pipetting.
7. Adding 40µl Proteinase K(10mg/ml) to sample mixture and vortex to mix sample.
8. Put the prepared Sample Tube into the correct well of T-Rack. (see page 3-10)
9. Put Elution Tube and Tip Plus Holder Set (HF16, Compact)/Pipette Tip (Super, Plus) into the correct wells of T-Rack. (see page 3-10)
10. Run Code 502 program at MagCore®.

## MagCore® Total RNA Whole Blood Kit

For total RNA extraction from human whole blood.

Applicable Models : HF16, Compact, HF48, Super, HF16 Plus, Plus II

### Cartridge Code 601

Cat.No.MRN-01 // MRN-02

#### Kit Contents

Check that the following parts are included in addition to the main unit:

##### Cat.No. MRN-01 Contents:

Pre-filled Cartridge Reagent.....	36 pcs.
Pipet Tip plus Holder Set.....	36 sets.
Sample Tube.....	36 pcs.
Elution Tube.....	36 pcs.
RBC Lysis Buffer(100ml).....	1 pcs.
RB Buffer(15ml).....	1 pcs.

##### Cat.No. MRN-02 Contents:

Pre-filled Cartridge Reagent.....	96 pcs.
Pipet Tip plus Holder Set.....	100 sets.
Sample Tube.....	100 pcs.
Elution Tube.....	100 pcs.
RBC Lysis Buffer(200ml).....	1 pcs.
RB Buffer(30ml).....	1 pcs.

#### Storage and Stability:

1. This kit should be stored at room temperature.
2. Shelf Life: 18 Months.

#### Cartridge Contents:

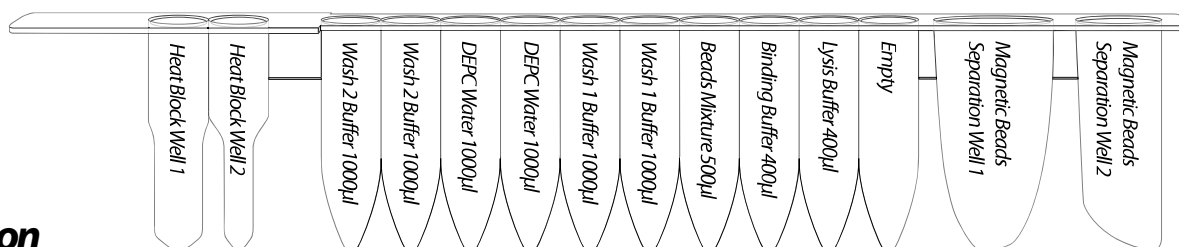

## Description

MagCore® Total RNA Whole Blood Kit is specially designed for total RNA purification from up to 400µl human whole blood of leukocytes. The program provides optional protocol for contaminated genomic DNA remove. Combine RBC high quality RNase-free DNase I with MagCore® Total RNA Whole Blood Kit can provide high quality DNA-free total RNA.

## Applications

Using magnetic-particle technology to purify total RNA. The purified RNA can be directly used for downstream application such as real-time PCR, RT-PCR, cDNA synthesis, etc.

## Preparation Before Using

1.  $\beta$ -Mercaptoethanol ( $\beta$ -ME; not provided) must be added to RB Buffer before use. Add 10  $\mu$ l of  $\beta$ -ME per 1 ml of RB Buffer.
2. Recommended Step: DNA residue degradation. Prepare DNase I (RNase-free) working solution according to the table below. Add 10  $\mu$ l DNase I with 190  $\mu$ l DNase reaction buffer (1X) in the 1.5 ml screw tube (not provided) and place it into well 3 of T-Rack.

Healthy Whole Blood	DNase I	DNase Buffer 1X
Up to 400 $\mu$ l	10 $\mu$ l	190 $\mu$ l

3. RNase-free DNase I is not including in MagCore® total RNA Whole Blood Kit, we recommend to use RBC RNase-free DNase I (Cat#DN036 or Cat#DN096) for genomic DNA treatment. For product information, please contact RBC Bioscience distributor. We also recommend to use RNase-free DNase I enzyme (1U/ $\mu$ l) of Novagen (Cat#69182-3). Please contact local Merck branch office or distributor for product information. 1X DNase Buffer can be prepared as following:

### 1X DNase I Reaction Buffer

10 mM Tris, pH 7.6; 2.5 mM MgCl<sub>2</sub>; 0.1 mM CaCl<sub>2</sub>; in DEPC water, autoclave.

## Fresh Whole Blood Protocol

### Without DNase I Treatment

1. Add 1 volume of human whole blood with 3 volumes of RBC lysis Buffer in an appropriately sized tube (not provided) and mix by inversion. Do not vortex. (For example, add 1200  $\mu$ l of RBC lysis Buffer to 400  $\mu$ l of whole blood.)
2. Incubate the tube for 10 minutes on ice and invert 2~3 times during incubation.
3. Centrifuge for 3 minutes at 500 x g (2,500 rpm) at 4°C and completely discard the supernatant.
4. Add 500  $\mu$ l RBC lysis Buffer to the cell pellet. Resuspend cells by vortex briefly.
5. Transfer the suspended cells to the MagCore® Sample Tube.
6. Centrifuge for 3 minutes at 500 x g (2,500 rpm) at 4°C and completely discard the supernatant.
7. Add 200  $\mu$ l RB buffer (contain  $\beta$ -ME) to the white pellet and mix by vortexing. (can storage up to 1 month at -80°C)
8. Put the prepared Sample Tube into the correct well of T-Rack. (see page 3-10)
9. Put Elution Tube and Tip Plus Holder Set (HF16, Compact) / Pipette Tip (Super, Plus) into the correct wells of T-Rack. (see page 3-10)
10. Run Code 601 program at MagCore® and select Remove Genomic DNA (2) NO.

### With DNase I Treatment

1. Follow step 1~9 of without DNase I treatment protocol to prepare whole blood cell sample.
2. Be sure to place the 200  $\mu$ l DNase I mixture (in 1.5 ml screw tube) into the well 3 of T-Rack.
3. Run Code 601 program at MagCore® and select Remove Genomic DNA (1) YES.

## MagCore® Total RNA FFPE One-Step Kit

For extraction of total RNA from formalin-fixed paraffin-embedded (FFPE) tissue by using MagCore® System.  
**Applicable Models : HF16, Compact, HF48, Super, HF16 Plus, Plus II**

### Cartridge Code 605

Cat No.MRF-01 //MRF-03

#### Kit Contents

Check that the following parts are included in addition to the main unit:

##### Cat.No. MRF-01 Contents:

Pre-filled Cartridge Reagent.....	24 pcs.
Pipet Tip plus Holder Set.....	50sets.
Elution Tube.....	25 pcs.
Sula Oil (25 ml).....	1 pcs.
Thermostable Cap.....	25 pcs.

##### Cat.No. MRF-03 Contents:

Pre-filled Cartridge Reagent.....	72 pcs.
Pipet Tip plus Holder Set.....	150 sets.
Elution Tube.....	75 pcs.
Sula Oil (50ml).....	1 pcs.
Thermostable Cap.....	75 pcs.

#### Storage and Stability:

1. This kit should be stored at room temperature (15-25°C).
2. Shelf Life:18 Months.

#### Cartridge Contents :

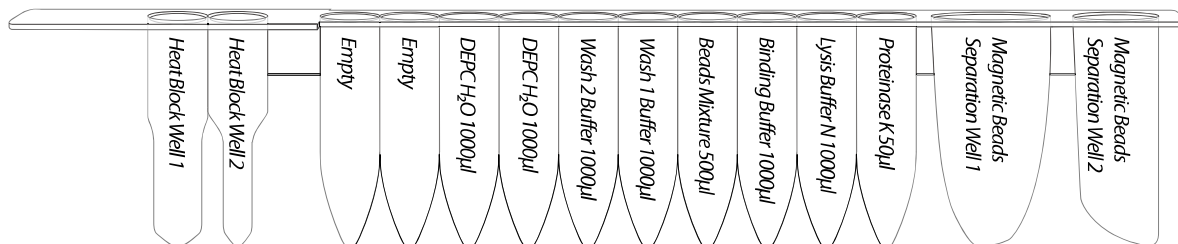

## Description

MagCore® total RNA FFPE One-Step Kit is specially designed for total RNA purification from FFPE tissues by MagCore® instruments. It features the method, one-step heating, to melt paraffin without harmful reagents involved such as xylene or other organic solvents, and lyse tissues at the same time. The MagCore® total RNA FFPE One-Step Kit System optimizes the lysis conditions to reverse the formalin fixation without the need for overnight digestion and retain both large and small RNAs. The program provides optional DNase I treatment to remove contaminated DNA.

## Applications

Using magnetic-particle technology to purify total RNA from FFPE tissues. The purified RNA can be directly used for downstream application such as real-time PCR, RT-PCR, cDNA synthesis, etc.

## Preparation Before Using

1. **Recommended Step: DNase I Treatment.** Prepare DNase I (RNase-free) working solution: add 10 µl DNase I with 16 µl DNase reaction buffer (1X) in 1.5 ml screw tube (not provided) and place it into the W4 (HF-16, Compact)/W1 (Super, Plus) of T-Rack.
2. RNase-free DNase I is not included in MagCore® Total RNA FFPE One-Step Kit, we recommend using RBC RNase-free DNase I (Cat#DN036 or Cat#DN096) for reducing the possibility of genomic DNA carryover. For more product information, please contact your local distributor.
3. **It is not available for optics measurement when you set up the elution volume is 40µl.**

### RNase Precautions

1. Before working with RNA, it is a good idea to use RNA decontamination solution to clean the lab bench, pipettors, and microtome.
2. When performing extraction with MagCore® Total RNA FFPE One-step Kit, always wear a suitable lab coat, disposable gloves, and protective mask. Do not talk during the experiment to avoid contamination.
3. Ensure that the experimental environment is suitable for operating RNA experiments.

## Needle-Like FFPE Tissue Sections Protocol

1. Cut 5-50µm sections from FFPE tissue blocks by using a microtome.
2. Take the equivalent of ≤50µm tissue sections into 1.5ml microcentrifuge tube. (See Important notes)
3. Trim the excess paraffin from the tissue sections.
4. Use a RNase-free pipette tip to put the tissue sections from step 3. into the bottom of **Heat Block well 1** of the cartridge.
5. Add 500µl of **Sula oil**, ensure the tissue sections can totally immerse in Sula oil\*, and cover it up with the **Thermostable cap**.
6. \*If samples are too long to immerse in Sula oil, use a RNase-free pipet tip to cut and push the samples into the solution.

## MagCore® Operation

### Without DNase I Treatment

1. Follow the **Needle-like FFPE sections Protocol step 1-4.**
2. Put Elution Tube and 2 set of Tip Plus Holder Set (HF16, Compact) / Pipette Tip and Tip Plus Holder Set (Super, Plus) into the correct wells of T-Rack. (see below graphs- Well Position of T-Rack)
3. Run Code 605 program at MagCore® and select "Select DNase treatment" (2) NO.

## Important Notes for Needle-Like FFPE Tissue Sections

Tissue Section (µm)	Sample Scroll
50	1-3
20	1-4
10	1-5 (Don't over load 5 scrolls)



## Glass-slide FFPE Tissue Samples Protocol

1. Put a few drops of Sula Oil on the glass slide and scrape them from the slide carefully, then put in the bottom of Heat Block well 1. (See Important notes)
2. Add 500µl Sula Oil into **Heat Block well 1**, rinse remaining sample on the wall and blade, then cover it up with the Thermostable cap.

## MagCore® Operation

### Without DNase I Treatment

1. Follow the **Glass-slide FFPE Tissue Samples Protocol Steps 1-2.**
2. Put Elution Tube and 2 set of Tip Plus Holder Set (HF16, Compact) / Pipette Tip and Tip Plus Holder Set (Super, Plus) into the correct wells of T-Rack. (see below graphs- Well Position of T-Rack)
3. Run Code 605 program at MagCore® and select "Select DNase treatment" (2) NO.

### With DNase I Treatment

1. Follow the **Needle-like FFPE Samples Protocol Steps 1-2.**
2. Be sure to place the 26 µl DNase I mixture (in 1.5 ml screw tube) into t the W4 (HF-16, Compact) / W1 (Super, Plus) of T-Rack. (see below graphs- Well Position of T-Rack)
3. Put Elution Tube and 2 set of Tip Plus Holder Set (HF16, Compact) / Pipette Tip and Tip Plus Holder Set (Super, Plus) into the correct wells of T-Rack. (see below graphs- Well Position of T-Rack)
4. Run Code 605 program at MagCore® and select "Select DNase treatment" (1) YES.

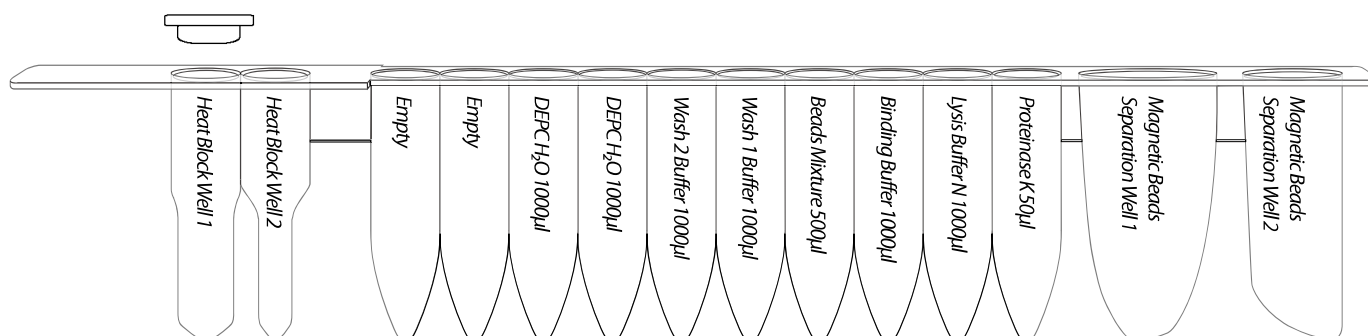



### Important Notes for Glass-slide FFPE Tissue Samples

1. The surface area of the FFPE tissue slide samples could be measured as following examples:

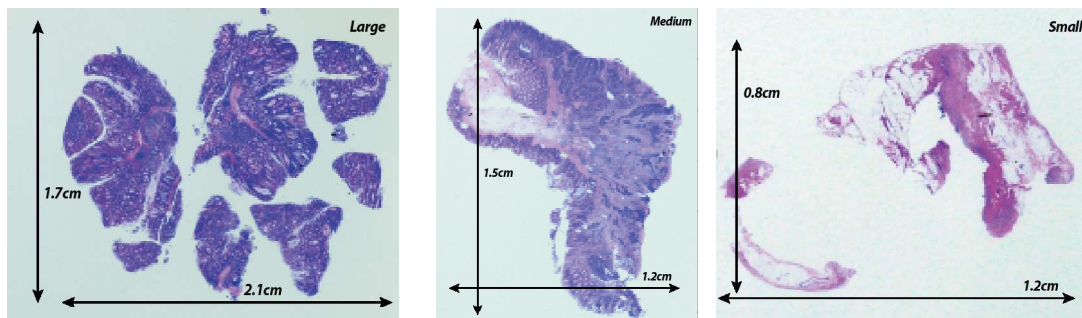

2. Slide samples amount of preparation can be 1-5 scrolls, **each with a thickness up to 5µm**. One FFPE scroll could be enough to analyze if the surface area is over 200mm<sup>2</sup>

Surface Area (mm <sup>2</sup> )	Sample Scroll
200 ↑	1
100-200	1-2
50-100	2-3
50 ↓	3-5

(Don't over load 5 scrolls)

\*Overload the sample or paraffin will clog the tip and decrease the yield.

- If you have no information about the sample, we recommend starting with 1-2 scrolls.
- Sula Oil is a deparaffin solution. The capacity of the Sula Oil (500µl) is about 20mg paraffin per preparation.

### Well Position of T-Rack

MagCore® Super/MagCore® HF16 Plus

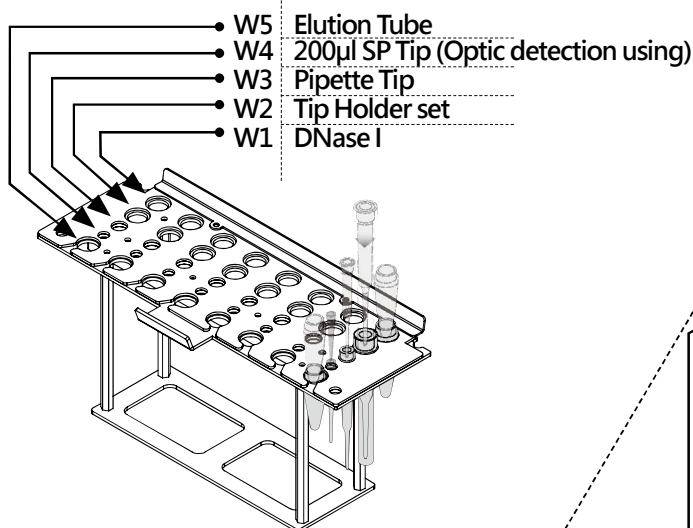

MagCore® HF16/MagCore® Compact

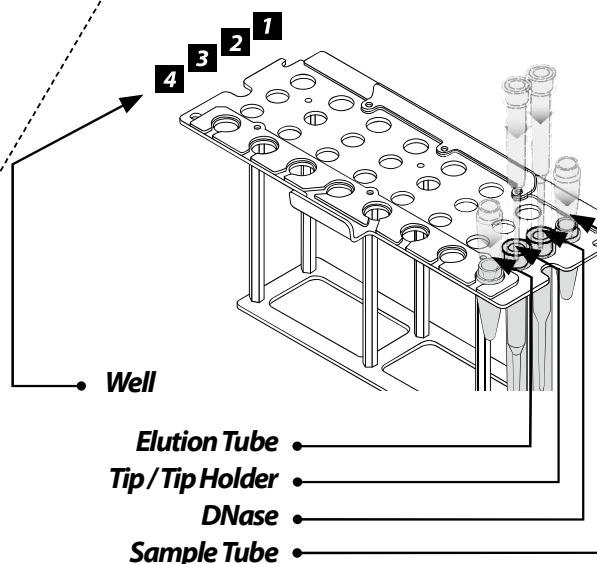

## MagCore® Total RNA Cultured Cells Kit

For total RNA extraction from cultured cells.

Applicable Models : HF16, Compact, HF48, Super, HF16 Plus, Plus II

### Cartridge Code 610

Cat.No.MRC-01 // MRC-02

#### Kit Contents

Check that the following parts are included in addition to the main unit:

##### Cat.No. MRC-01 Contents:

Pre-filled Cartridge Reagent.....	36 pcs.
Pipet Tip plus Holder Set.....	36 sets.
Sample Tube.....	36 pcs.
Elution Tube.....	36 pcs.
RB Buffer(15ml).....	1 pcs.

##### Cat.No. MRC-02 Contents:

Pre-filled Cartridge Reagent.....	96 pcs.
Pipet Tip plus Holder Set.....	100 sets.
Sample Tube.....	100 pcs.
Elution Tube.....	100 pcs.
RB Buffer(30ml).....	1 pcs.

#### Storage and Stability:

1. This kit should be stored at room temperature.
2. Shelf Life: 18 Months.

#### Cartridge Contents :

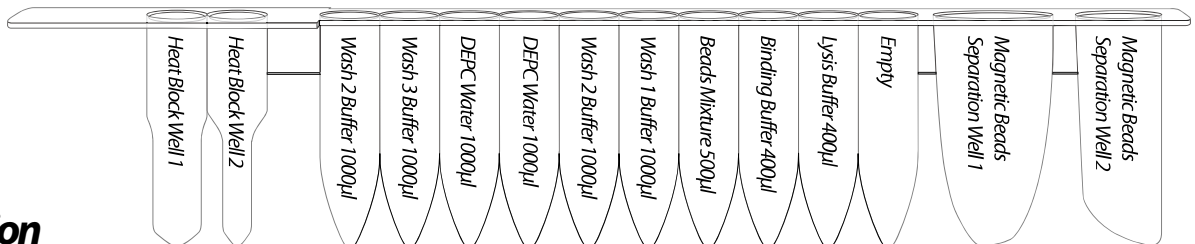

## Description

MagCore® Total RNA Cultured Cells Kit is specially designed for total RNA purification from up to  $1 \times 10^6$  cultured cells by using MagCore® auto-extraction instrument. The program provides optional protocol for contaminated genomic DNA remove. Combine RBC high quality RNase-free DNase I with MagCore® Total RNA Cultured Cells Kit can provide high quality DNA-free total RNA.

## Applications

Using magnetic-particle technology to purify total RNA from cultured cells, human whole blood, and animal tissue samples. The purified RNA can be directly used for downstream applications such as real-time PCR, RT-PCR, cDNA synthesis, etc.

## Preparation Before Using

1.  $\beta$ -Mercaptoethanol ( $\beta$ -ME; not provided) must be added to RB Buffer before use. Add 10  $\mu$ l of  $\beta$ -ME per 1 ml of RB Buffer.
2. Recommended Step: DNA residue degradation. Prepare DNase I (RNase-free) working solution according to the table below. Add 10  $\mu$ l DNase I with 190  $\mu$ l DNase reaction buffer (1X) in the 1.5 ml screw tube (not provided) and place it into well 3 of T-Rack.

Cultured Cells	DNase I	1X DNase Buffer
Up to $1 \times 10^6$	10 $\mu$ l	190 $\mu$ l

3. RNase-free DNase I is not including in MagCore® total RNA Cultured Cells Kit, we recommend to use RBC RNase-free DNase I (Cat#DN036 or Cat#DN096) for genomic DNA treatment. For product information, please contact RBC Bioscience distributor. We also recommend to use RNase-free DNase I enzyme (1U/ $\mu$ l) of Novagen (Cat#69182-3). Please contact local Merck branch office or distributor for product information. 1X DNase Buffer can be prepared as following:

### 1X DNase I Reaction Buffer

10 mM Tris, pH 7.6; 2.5 mM MgCl<sub>2</sub>; 0.1 mM CaCl<sub>2</sub>; in DEPC water, autoclave.

## Cultured Cells Protocol

### Sample Preparation

#### A. Cells grown in suspension

Cells grown in suspension (up to  $1 \times 10^6$  cells). Determine the number of cells. Transfer appropriate number of cells to the MagCore® Sample Tube (provided) and centrifuge for 5 min. at 300 x g. Remove the supernatant completely and discard. Continue with MagCore® Operation step.

#### B. Cells grown in a monolayer

Cells grown in a monolayer (up to  $1 \times 10^6$  cells). Cells grown in a monolayer can be detached from the culture flask by either trypsinization or using a cell scraper.

#### To trypsinize cells:

Determine the number of cells. Aspirate the medium and wash cells with PBS (not provided). Aspirate the PBS, and add 0.10–0.25% trypsin. After cells have detached from the dish or flask, collect them in medium, and transfer the appropriate number of cells (up to  $1 \times 10^6$  cells) to the MagCore® Sample Tube (provided). Centrifuge for 5 min. at 300 x g. Remove the supernatant completely and discard, taking care not to disturb the cell pellet. Continue with MagCore® Operation step.

#### Using a cell scraper:

Detach cells from the dish or flask. Transfer the appropriate number of cells (up to  $1 \times 10^6$  cells) to the MagCore® Sample Tube (provided) and centrifuge for 5 min. at 300 x g. Remove the supernatant completely and discard, taking care not to disturb the cell pellet. Continue with MagCore® Operation step.

## MagCore® Operation

### Without DNase I Treatment

1. Add 200  $\mu$ l RB buffer (contain  $\beta$ -ME) to the cells pellet and mix by vortexing (can storage up to 1 month at  $-80^{\circ}\text{C}$ ).
2. Put the prepared Sample Tube into the correct well of T-Rack. (see page 3-10)
3. Put Elution Tube and Tip Plus Holder Set (HF16, Compact) / Pipette Tip (Super, Plus) into the correct wells of T-Rack. (see page 3-10)
4. Run Code 610 program at MagCore® and select Remove Genomic DNA (2) NO.

### With DNase I Treatment

1. Follow step 1~3 of without DNase I treatment protocol to prepare culture cell sample.
2. Be sure to place the 200  $\mu$ l DNase I mixture (in 1.5 ml screw tube) into the well 3 of T-Rack.
3. Run Code 610 program at MagCore® and select Remove Genomic DNA (1) YES.

## MagCore® triXact RNA Kit

For extraction of total RNA from cultured cells, whole blood and tissues.

Applicable Models : HF16, Compact, HF48, Super, HF16 Plus, Plus II

### Cartridge Code 631

Cat.No.MRX-01 // MRX-03

#### Kit Contents

Check that the following parts are included in addition to the main unit:

##### Cat.No. MRX-01 Contents:

Pre-filled Cartridge Reagent.....	24pcs.
Pipet Tip plus Holder Set.....	25pcs.
Sample Tube.....	25pcs.
Elution Tube.....	25pcs.
RBC Lysis Buffer (100 ml).....	1 pcs.
RB Buffer(30ml).....	1 pcs.
Filter column Set.....	25pcs.

##### Cat.No. MRX-03 Contents:

Pre-filled Cartridge Reagent.....	72pcs.
Pipet Tip plus Holder Set.....	75pcs.
Sample Tube.....	75pcs.
Elution Tube.....	75pcs.
RBC Lysis Buffer (200 ml).....	1 pcs.
RB Buffer(60ml).....	1 pcs.
Filter column Set.....	75pcs.

#### Storage and Stability:

1. This kit should be stored at room temperature.
2. Shelf Life:18 Months.

#### Cartridge Contents:

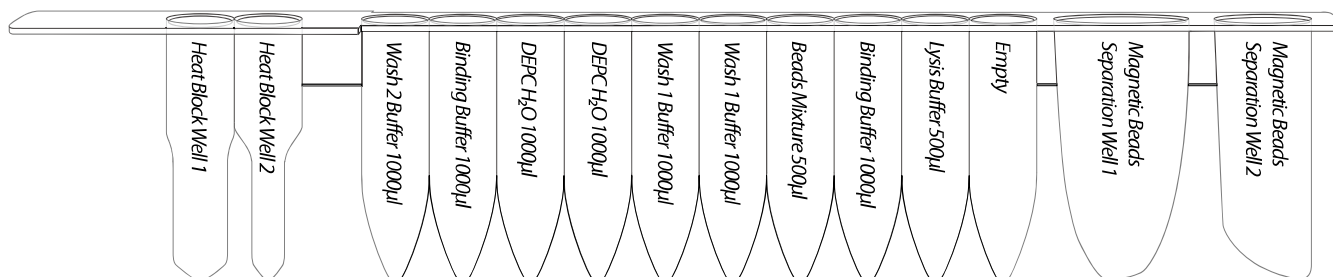

## Description

MagCore® triXact RNA Kit is specially designed for total RNA purification from up to  $5 \times 10^6$  cultured cells, a variety of tissues, or whole blood. The program provides optional DNase I treatment to remove residual DNA from contaminating the results. High quality DNA-free RNA can be extracted using this kit along with our RNase-free DNase I.

## Applications

Using magnetic-particle technology to purify total RNA from cultured cells, human whole blood, and animal tissue samples. The purified RNA can be directly used for downstream application such as real-time PCR, RT-PCR, cDNA synthesis, etc.

## Preparation Before Using

1.  $\beta$ -Mercaptoethanol ( $\beta$ -ME; not provided) must be added to RB Buffer before use. Add 10  $\mu$ l of  $\beta$ -ME per 1 ml of RB Buffer.
2. Recommended Step: DNase I Treatment. Prepare DNase I (RNase-free) working solution: add 10  $\mu$ l DNase I with 190  $\mu$ l DNase reaction buffer (1X) in 1.5 ml screw tube (not provided) and place it into the correct wells of T-Rack. (see page 3-10)
3. RNase-free DNase I is not included in MagCore® triXact RNA Kit, we recommend using RBC RNase-free DNase I (Cat#DN036 or Cat#DN096) for genomic DNA treatment. For more product information, please contact your local distributor.

### Important Notes

1. When fresh samples (including whole blood, cells, and tissues) are obtained, samples are subjected to the following protocol as soon as possible (within one day). If you do not extract RNA immediately, lyse the samples in the RB buffer for stabilization. The samples can be stored at  $-80^{\circ}\text{C}$  up to 1 month in the RB buffer.
2. When doing extraction with MagCore® triXact RNA Kit, always wear a suitable lab coat, disposable gloves, and protective mask. Also, **always keep the samples on ice as much as possible**. Do not talk during the experiment to avoid contamination.
3. Ensure that the experimental environment is suitable for operating RNA experiments. Performing the extraction in the hood is recommended.

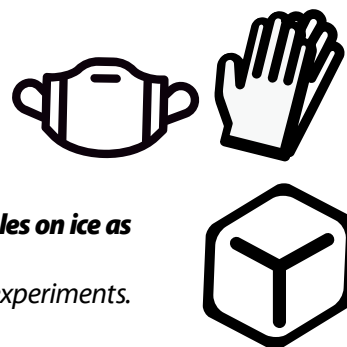

## Cultured Cells Protocol

### Sample Preparation

#### A. Cells grown in suspension

For cells grown in suspension (up to  $5 \times 10^6$  cells), first determine the number of cells. Transfer appropriate number of cells to the MagCore® Sample Tube (provided) and centrifuge at 300g for 5 minutes. Remove the supernatant completely and discard. Continue with MagCore® Operation steps.

#### B. Cells grown in a monolayer

For cells grown in a monolayer (up to  $5 \times 10^6$  cells), cells can be detached from the culture flask by either trypsinization or using a cell scraper

#### To trypsinize cells:

Determine the number of cells. Aspirate the medium and wash cells with PBS (not provided). Aspirate the PBS, and add 0.10-0.25% trypsin. Once cells have detached from the dish or flask, collect them in medium, and transfer the appropriate number of cells (up to  $5 \times 10^6$  cells) to the MagCore® Sample Tube (provided). Centrifuge at 300g for 5 minutes. Remove the supernatant completely and discard. Be careful not to disturb the cell pellet. Continue with MagCore® Operation steps.

#### Using a cell scraper:

Detach cells from the dish or flask. Transfer the appropriate number of cells (up to  $5 \times 10^6$  cells) to the MagCore® Sample Tube (provided) and centrifuge at 300g for 5 minutes. Remove the supernatant completely and discard. Be careful not to disturb the cell pellet. Continue with MagCore® Operation steps.

## MagCore® Operation

### Without DNase I Treatment

1. Follow the important notes for the following step.
2. Add 400  $\mu$ l RB Buffer (contain  $\beta$ -ME) to the cell pellet and mix by vortexing, keep the samples on ice. (can store up to 1 month at  $-80^{\circ}\text{C}$ )
3. Put the prepared Sample Tube into the correct well of T-Rack. (see page 3-10)
4. Put Elution Tube and Tip Plus Holder Set (HF16, Compact) / Pipette Tip (Super, Plus) into the correct wells of T-Rack. (see page 3-10)
5. Run Code 631 program at MagCore® and select (2) NO to "Select DNase treatment".

### With DNase I Treatment

1. Follow step 1~3 of without DNase I treatment protocol to prepare cultured cells sample.
2. Be sure to place the 200  $\mu$ l DNase I mixture (in 1.5 ml screw tube) into the correct well of T-Rack. (see page 3-10)
3. Run Code 631 program at MagCore® and select (1) YES for Select DNase treatment.

## **Fresh Whole Blood Protocol**

### **Without DNase I Treatment**

1. Follow the important notes for the following step.
2. Add 1 volume of human whole blood with 3 volumes of RBC lysis Buffer in an appropriately sized tube (not provided) and mix by inversion. Do not vortex. (For example, add 1200 µl of RBC lysis Buffer to 400 µl of whole blood.)
3. Incubate the tube on ice for 10 minutes and invert 2~3 times during incubation.
4. Centrifuge for 3 minutes at 500 x g (2500rpm) at 4°C and completely discard the supernatant.
5. Add 500 µl RBC lysis Buffer to the cell pellet. Resuspend cells by brief vortexing, keep the samples on ice.
6. Transfer the suspended cells to the MagCore® Sample Tube.
7. Centrifuge for 3 minutes at 500 x g (2500rpm) at 4°C and discard the supernatant completely.
8. Add 400 µl RB buffer (contain β-ME) to the pellet and mix by vortexing, keep the samples on ice (can store up to 1 month at -80°C).
9. Put the prepared Sample Tube into the correct well of T-Rack. (see page 3-10)
10. Put Elution Tube and Tip Plus Holder Set (HF16, Compact) / Pipette Tip (Super, Plus) into the correct wells of T-Rack. (see page 3-10)
11. Run Code 631 program on MagCore® and select DNase treatment (2) NO.

### **With DNase I Treatment**

1. Follow step 1~9 of the protocol above (without DNase I treatment) to prepare whole blood cell sample.
2. Be sure to place the 200 µl DNase I mixture (in 1.5 ml screw tube) into the correct well of T-Rack. (see page 3-10)
3. Run Code 631 program on MagCore® and select (1) YES for Select DNase treatment.



## Tissue Protocol

### Cell Lysis

1. Follow the important notes for the following step.
2. Cut off up to 50 mg of fresh or frozen animal tissue and transfer into a RNase-free microcentrifuge tube(not provided).
3. Add 400  $\mu$ l RB Buffer (containing  $\beta$ -ME) into the tube and use RNase-free micropestle (not provided) to sufficiently grind the tissue a few times.
4. Incubate at room temperature for 5 minutes. Use a Filter Column Set and apply sample mixture to the column.
5. Centrifuge the filtrate for 2 minutes at full speed (10000 x g or 13000 rpm) and transfer the clear supernatant to Sample Tube, keep the samples on ice.

### Without DNase I Treatment

1. Put the prepared Sample Tube into the correct well of T-Rack. (see page 3-10)
2. Put Elution Tube and Tip Plus Holder Set (HF16, Compact) / Pipette Tip (Super, Plus) into the correct wells of T-Rack. (see page 3-10)
3. Run Code 631 program on MagCore® and select (2) NO to "Select DNase treatment".

### With DNase I Treatment

1. Follow step 1~2 of without DNase I treatment protocol to prepare tissue sample.
2. Be sure to place the 200  $\mu$ l DNase I mixture (in 1.5 ml screw tube) into the correct well of T-Rack. (see page 3-10)
3. Run Code 631 program on MagCore® and select (1) YES for Select DNase treatment.

# Running Time List - MagCore® HF16, Compact

Cat. Number	Product	Reactions	Code No.	Running Time
MGB400-01	MagCore® Genomic DNA Whole Blood Kit (Speedy Installation)	36	101	44 min (sample volume :200 µl)
MGB400-02		96		57 min (sample volume :400 µl)
MGB400-03	MagCore® Genomic DNA Whole Blood Kit	36	102	44 min (sample volume :200 µl)
MGB400-04		96		55 min (sample volume :400 µl)
MGB1200	MagCore® Genomic DNA Large Volume Whole Blood Kit	96	104	76 min (sample volume :1200 µl)
MPD1200	MagCore® Plasma DNA Extraction Kit	96	105	70 min (sample volume :1200 µl)
MGB400-07	MagCore® Genomic DNA Whole Blood Kit (For Genotyping)	36	106	44min (sample volume :200 µl)
MGB400-08		96		57min (sample volume :400 µl)
MCC-01	MagCore® Cultured Cells DNA Kit	36	110	44 min
MCC-02		96		(sample volume: 200 µl, up to 5 x 10 <sup>6</sup> cells)
MPD-4000-01	MagCore® Circulating DNA Large Volume Kit (4 ml)	24	115	146 min (sample volume :400 µl)
MPD-4000-03		96		
MVN400-01	MagCore® Viral Nucleic Acid Extraction Kit	36	201	45 min (sample volume :200 µl)
MVN400-02		96		56 min (sample volume :400 µl)
MVN400-03	MagCore® Viral Nucleic Acid Extraction Kit	36	202	57 min (sample volume :200 µl)
MVN400-04		96		66 min (sample volume :400 µl)
MVN400-05	MagCore® Viral Nucleic Acid Extraction Kit (High Sensitivity)	36	203	57 min (sample volume :200 µl)
MVN400-06		96		66 min (sample volume :400 µl)
MVN2400	MagCore® Viral Nucleic Acid Extraction Kit (2.4ml)	96	210	90 min (sample volume :2400 µl)
MVN1200	MagCore® Viral Nucleic Acid Extraction Kit (1.2ml)	96	211	73 min (sample volume :1200 µl)
MGP-01	MagCore® Genomic DNA Plant Kit	36	301	33 min (sample volume :400 µl)
MGP-02		96		
MGT-01	MagCore® Genomic DNA Tissue Kit	36	401	33 min (sample volume :400 µl)
MGT-02		96		
MGF-01	MagCore® Genomic DNA FFPE One-Step Kit	36	405	175 min (2-hour heating) - Standard
MGF-02		96		1007 min (16-hour heating) - High Yield
MBB-01	MagCore® Genomic DNA Bacterial Kit	36	502	44 min (sample volume :200 µl)
MBB-02		96		
MRN-01	MagCore® Total RNA Whole Blood Kit	36	601	42min (without DNase I treatment)
MRN-02		96		68min (with DNase I treatment) (sample volume :200 µl)
MRF-01	MagCore® Total RNA FFPE One-Step Kit	24	605	147min (without DNase I treatment)
MRF-03		72		165min (with DNase I treatment)
MRC-01	MagCore® Total RNA Cultured Cells Kit	36	610	42min (without DNase I treatment)
MRC-02		96		73 min (with DNase I treatment) (sample volume :200 µl)
MRX-01	MagCore® triXact RNA Kit	24	631	58min (without DNase I treatment)
MRX-03		72		73min (with DNase I treatment)



# Running Time List - MagCore® Super, HF16 Plus, Plus II

Cat. Number	Product	Reactions	Code No.	Running Time Without Optical Detection
MGB400-01	MagCore® Genomic DNA Whole Blood Kit (Speedy Installation)	36	101	39 min (sample volume :200 µl)
MGB400-02		96		50 min (sample volume :400 µl)
MGB400-03	MagCore® Genomic DNA Whole Blood Kit	36	102	39min (sample volume :200 µl)
MGB400-04		96		50min (sample volume :400 µl)
MGB1200	MagCore® Genomic DNA Large Volume Whole Blood Kit	96	104	83 min (sample volume :1200 µl)
MPD1200	MagCore® Plasma DNA Extraction Kit	96	105	74 min (sample volume :1200 µl)
MGB400-07	MagCore® Genomic DNA Whole Blood Kit (For Genotyping)	36	106	41 min (sample volume :200 µl)
MGB400-08		96		53min (sample volume :400 µl)
MCC-01	MagCore® Cultured Cells DNA Kit	36	110	39 min (sample volume: 200 µl)
MCC-02		96		
MPD-4000-01	MagCore® Circulating DNA Large Volume Kit (4 ml)	24	115	146 min (sample volume :400 µl)
MPD-4000-03		96		
MVN400-01	MagCore® Viral Nucleic Acid Extraction Kit	36	201	44 min (sample volume :200 µl)
MVN400-02		96		55 min (sample volume :400 µl)
MVN400-03	MagCore® Viral Nucleic Acid Extraction Kit	36	202	56 min (sample volume :200 µl)
MVN400-04		96		72 min (sample volume :400 µl)
MVN400-05	MagCore® Viral Nucleic Acid Extraction Kit (High Sensitivity)	36	203	56 min (sample volume :200 µl)
MVN400-06		96		72 min (sample volume :400 µl)
MVN1200	MagCore® Viral Nucleic Acid Extraction Kit (1.2ml)	96	211	80 min (sample volume :1200 µl)
MGP-01	MagCore® Genomic DNA Plant Kit	36	301	33 min (sample volume :400 µl)
MGP-02		96		
MGT-01	MagCore® Genomic DNA Tissue Kit	36	401	33 min (sample volume :400 µl)
MGT-02		96		
MGF-01	MagCore® Genomic DNA FFPE One-Step Kit	36	405	162 min (2-hour heating) - Standard 989 min (16-hour heating) - High Yield
MGF-02		72		
MFC-03	MagCore® Forensic DNA Direct Kit	72	406A	120 min
			406B	220 min
			406C	180 min
MBB-01	MagCore® Genomic DNA Bacterial Kit	36	502	39 min (sample volume :200 µl)
MBB-02		96		
MRN-01	MagCore® Total RNA Whole Blood Kit	36	601	45 min (without DNase I treatment) 70 min (with DNase I treatment ) (sample volume :200 µl)
MRN-02		96		
MRF-01	MagCore® Total RNA FFPE One-Step Kit	24	605	140min (without DNase I treatment) 158min (with DNase I treatment)
MRF-03		72		
MRC-01	MagCore® Total RNA Cultured Cells Kit	36	610	52 min (without DNase I treatment) 74 min (with DNase I treatment) (sample volume :200 µl)
MRC-02		96		
MRX-01	MagCore® triXact RNA Kit	24	631	48min (without DNase I treatment) 81min (with DNase I treatment)
MRX-03		72		

\*Optical detection tact time: 15 min

# Running Time List - MagCore® HF48

Cat. Number	Product	Reactions	Code No.	Running Time	
				24 samples (min)	48 samples (min)
MGB400-01	MagCore® Genomic DNA Whole Blood Kit (Speedy Installation)	36	101	44 (400 µl sample)	93 (400 µl sample)
MGB400-02		96		54 (200 µl sample)	110 (200 µl sample)
MGB400-03	MagCore® Genomic DNA Whole Blood Kit	36	102	44 (400 µl sample)	93 (400 µl sample)
MGB400-04		96		54 (200 µl sample)	110 (200 µl sample)
MGB1200	MagCore® Genomic DNA Large Volume Whole Blood Kit	96	104	72 min	143 min
MPD1200	MagCore® Plasma DNA Extraction Kit	96	105	62 min	124 min
MGB400-07	MagCore® Genomic DNA Whole Blood Kit (For Genotyping)	36	106	44 (400 µl sample)	93 (400 µl sample)
MGB400-08		96		54 (200 µl sample)	110 (200 µl sample)
MVN400-01	MagCore® Viral Nucleic Acid Extraction Kit	36	201	45 (400 µl sample)	93 (400 µl sample)
MVN400-02		96		51 (200 µl sample)	106 (200 µl sample)
MVN400-03	MagCore® Viral Nucleic Acid Extraction Kit	36	202	55 (400 µl sample)	107 (400 µl sample)
MVN400-04		96		63 (200 µl sample)	125 (200 µl sample)
MVN400-05	MagCore® Viral Nucleic Acid Extraction Kit (High Sensitivity)	36	203	55 (400 µl sample)	107 (400 µl sample)
MVN400-06		96		63 (200 µl sample)	125 (200 µl sample)
MVN1200	MagCore® Viral Nucleic Acid Extraction Kit (1.2ml)	96	211	68 min	
MGT-01	MagCore® Genomic DNA Tissue Kit	36	401	34 min	71 min
MGT-02		96			
MBB-01	MagCore® Genomic DNA Bacterial Kit	36	502	45 min	91 min
MBB-02		96			
MRN-01	MagCore® Total RNA Whole Blood Kit	36	601	24 samples 79 min (without Dnase I treatment) *sample volume: 200µl	
MRN-02		96			
MRC-01	MagCore® Total RNA Cultured Cells Kit	36	610	24 samples 79 mins (without Dnase I treatment) *sample volume: 200µl	
MRC-02		96			



# Ordering Information

Product	Contents	Cat. No.
<b>Accessories of HF16</b>		
Cartridge Rack		MRC001
T-Rack	For General Use	MRC002
T-Rack (for 5 ml sample tube)	For MVN2400	MRC003
<b>Accessories of HF16 Plus, Super and Plus II</b>		
Cartridge Rack		P46020018
T-Rack		P46020019
MagCore® Cuvette Set	10 pcs	MSC010
	100 pcs	MSC100
Thermal Paper	(57mmx 50mm x12mm) *1 roll	P46020008
	(57mmx 50mm x12mm) *5 roll	P46020009
SP T-Rack (For 5 ml Sample Tube)	For MagCore HF16 PLUS/ SUPER Tip/Tube Rack (8-slot rack)	P46020066
Standard Tip Rack for Plus II	For MagCore Plus II Standard Tip/Tube Rack (16-slot rack)	P46030003
PLUS II T-Rack (For 5 ml Sample Tube)	For MagCore Plus II Tip/Tube Rack (16-slot rack)	P46030002
Extraction Tray Sets	For MagCore Plus II Tray Set	P46030006
Paper Bin Bags For Plus II (50 pcs)	For MagCore Plus II 50 Bin Bags / Package	MPB50
Paper Bin Bags For Super/HF16 Plus (50 pcs)	For MagCore HF16 PLUS/ SUPER / 50 Bin Bags / Package	MSB50
<b>Enzyme</b>		
Proteinase K Set	11 mg Proteinase K, 1.25 ml PK Storage Buffer	PK011
RNase A	50 µl RNase A (50mg/ml)	RN050
	130 µl RNase A (50mg/ml)	RN130
Lysozyme	Lysozyme 20 mg/ vial x1	YLY20
	Lysozyme 250 mg/ vial x4	YLY250
DNase I Set	For 36 Reactions RNase-Free DNase I (Lyophilized):1500 Kunitz Units x 1 Vial, 1 ml RNase-Free Water x1, 15 ml DNase I Reaction Buffer	DN036
	For 96 Reactions RNase-Free DNase I (Lyophilized):1500 Kunitz Units x 2 Vials, 1 ml RNase-Free Water x 2, 30 ml DNase I Reaction Buffer	DN096







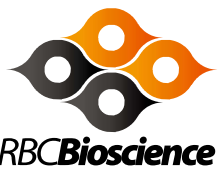

**RBC Bioscience Corp.**

[www.rbcbioscience.com](http://www.rbcbioscience.com)

[info@rbcbioscience.com](mailto:info@rbcbioscience.com)



RBC Bioscience Corp.  
3F., No.132, Ln. 235, Baoqiao Rd., Xindian Dist.,  
New Taipei City 23145, TAIWAN.  
TEL : +886-2-8912-1200 FAX : +886-2-8912-1300



Obelis s.a (obelis.net) Bd. Général  
Wahis 53 1030 Brussels, BELGIUM

